

# 2018 KX™ 65 PARTS DIAGRAM

Cylinder Head/Cylinder

E1110

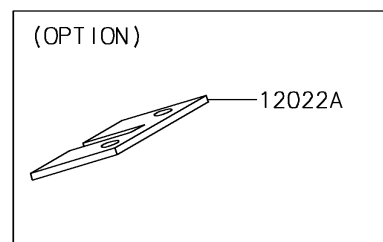
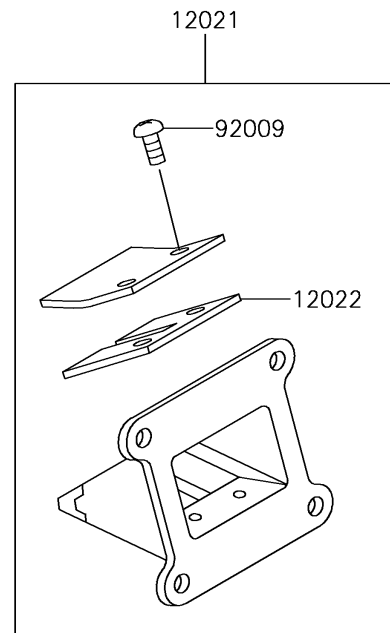
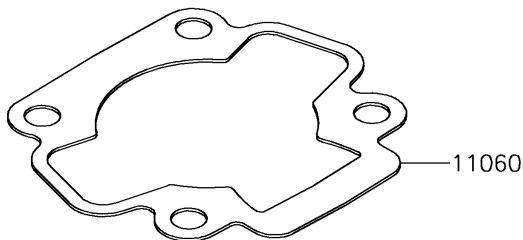
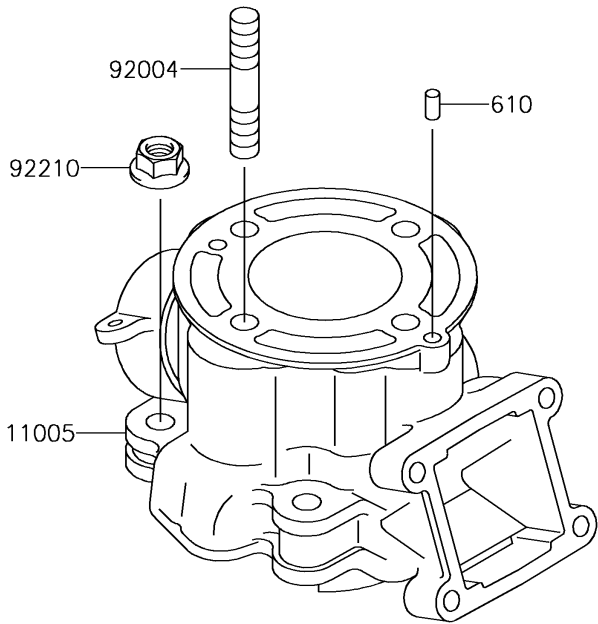
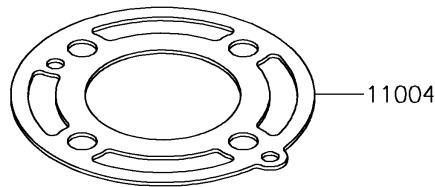
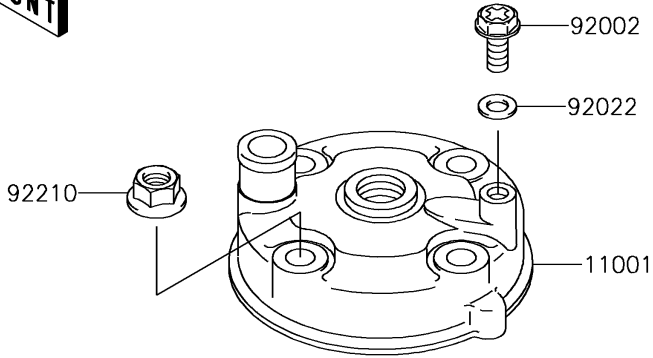

## 2018 KX™ 65 PARTS LIST

### Cylinder Head/Cylinder

ITEM NAME	PART NUMBER	QUANTITY
HEAD-CYLINDER (Ref # 11001)	11001-1516	1
GASKET-HEAD (Ref # 11004)	11004-1346	1
CYLINDER-ENGINE (Ref # 11005)	11005-1973	1
GASKET,CYLINDER BASE,T=0.37 (Ref # 11060)	11060-1921	1
VALVE-ASSY-REED (Ref # 12021)	12021-1015	1
VALVE-REED,T=0.42 (Ref # 12022)	12022-1013	2
VALVE-REED,T=0.37,CARBON (Ref # 12022A)	12022-1087	2
ROLLER,4X8 (Ref # 610)	610A0408	2
BOLT,6X10 (Ref # 92002)	92002-1222	1
STUD,8X30 (Ref # 92004)	92004-1069	4
SCREW,REED VALVE (Ref # 92009)	92009-1014	4
WASHER,6.2X11X1 (Ref # 92022)	92022-304	1
NUT,8MM (Ref # 92210)	92210-0076	8