

# 2017 KX™ 65 PARTS DIAGRAM

Swingarm

F2141

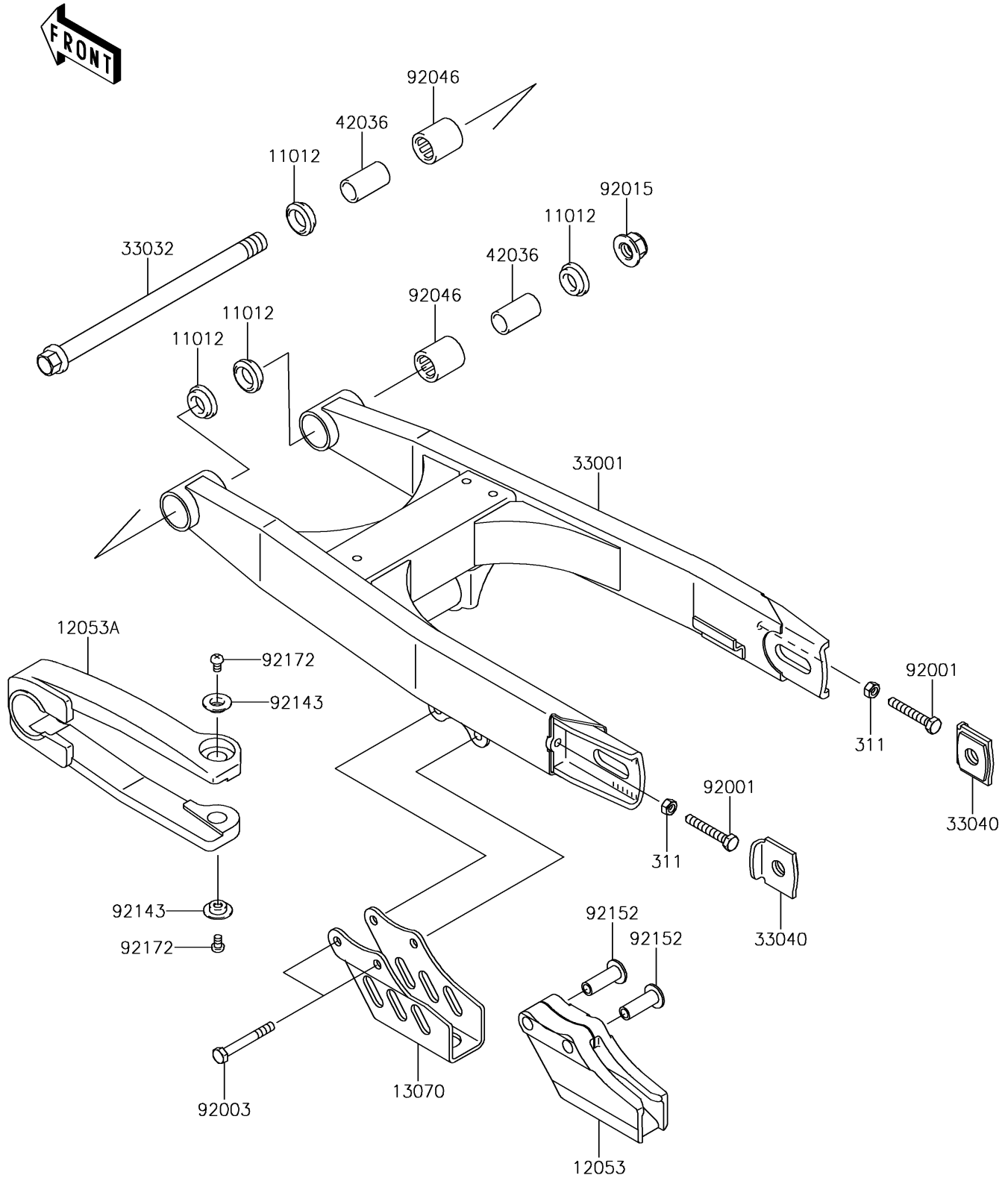

## 2017 KX™ 65 PARTS LIST

### Swingarm

ITEM NAME	PART NUMBER	QUANTITY
CAP (Ref # 11012)	11012-1263	4
GUIDE-CHAIN,RR (Ref # 12053)	12053-1436	1
GUIDE-CHAIN,FR (Ref # 12053A)	12053-1456	1
GUIDE,CHAIN (Ref # 13070)	13070-1347	1
NUT-HEX,6MM (Ref # 311)	311AA0600	2
ARM-COMP-SWING,P.SILVER (Ref # 33001)	33001-1634-458	1
SHAFT-SWING ARM (Ref # 33032)	33032-1194	1
ADJUSTER-CHAIN (Ref # 33040)	33040-1188	2
SLEEVE,SWING ARM,L=34 (Ref # 42036)	42036-1067	2
BOLT,6X39 (Ref # 92001)	92001-1463	2
BOLT,FLANGED,6X48 (Ref # 92003)	92003-179	2
NUT,LOCK,FLANGED,12MM (Ref # 92015)	92015-1433	1
BEARING-NEEDLE (Ref # 92046)	92046-1046	2
COLLAR (Ref # 92143)	92143-1676	2
COLLAR (Ref # 92152)	92152-1215	2
SCREW,5X8 (Ref # 92172)	92172-0119	2