

2016 KX™ 250F PARTS DIAGRAM

Oil Pump

E1710

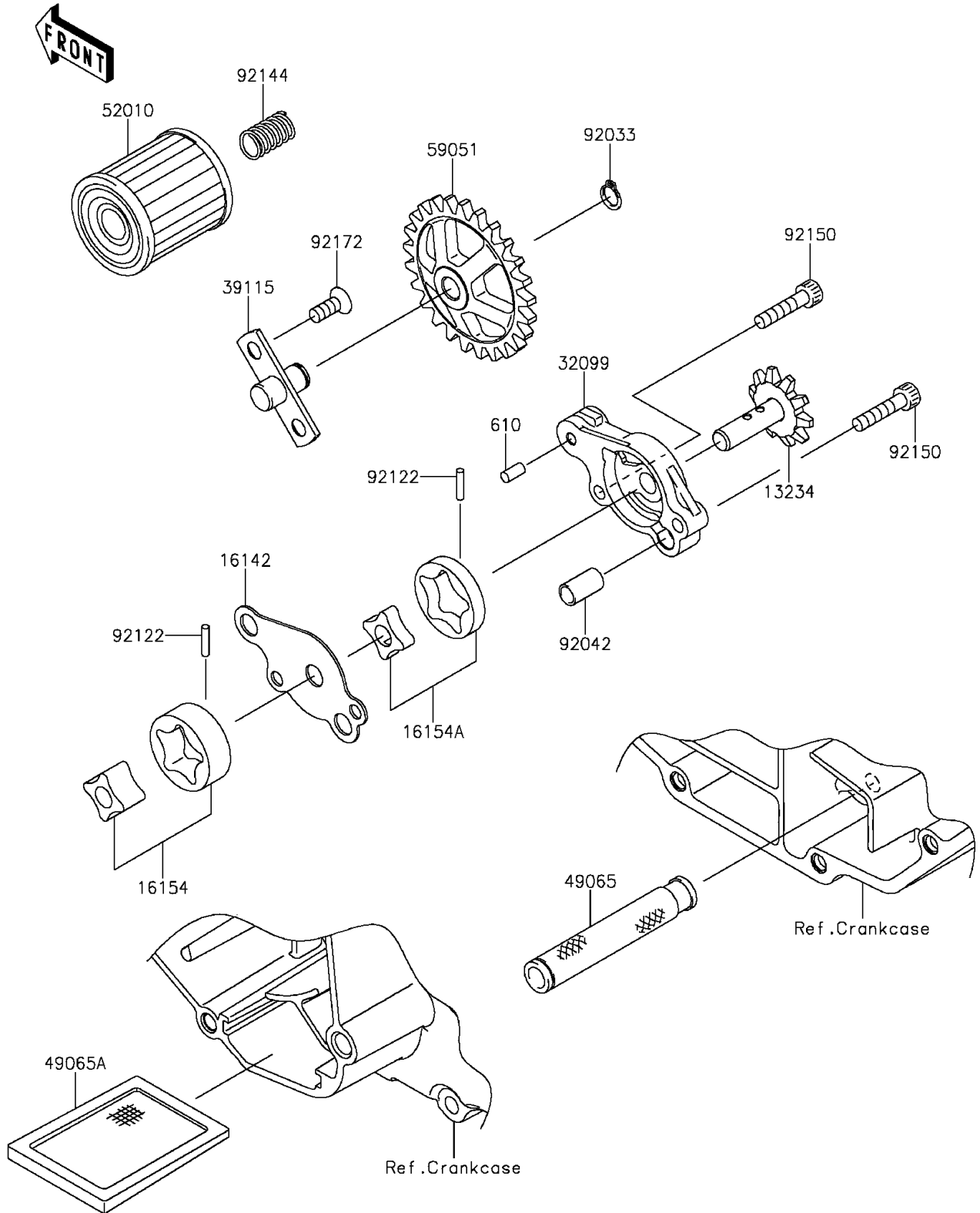

2016 KX™ 250F PARTS LIST

Oil Pump

ITEM NAME	PART NUMBER	QUANTITY
-----------	-------------	----------