

2017 Ninja 300 PARTS DIAGRAM

Cylinder Head

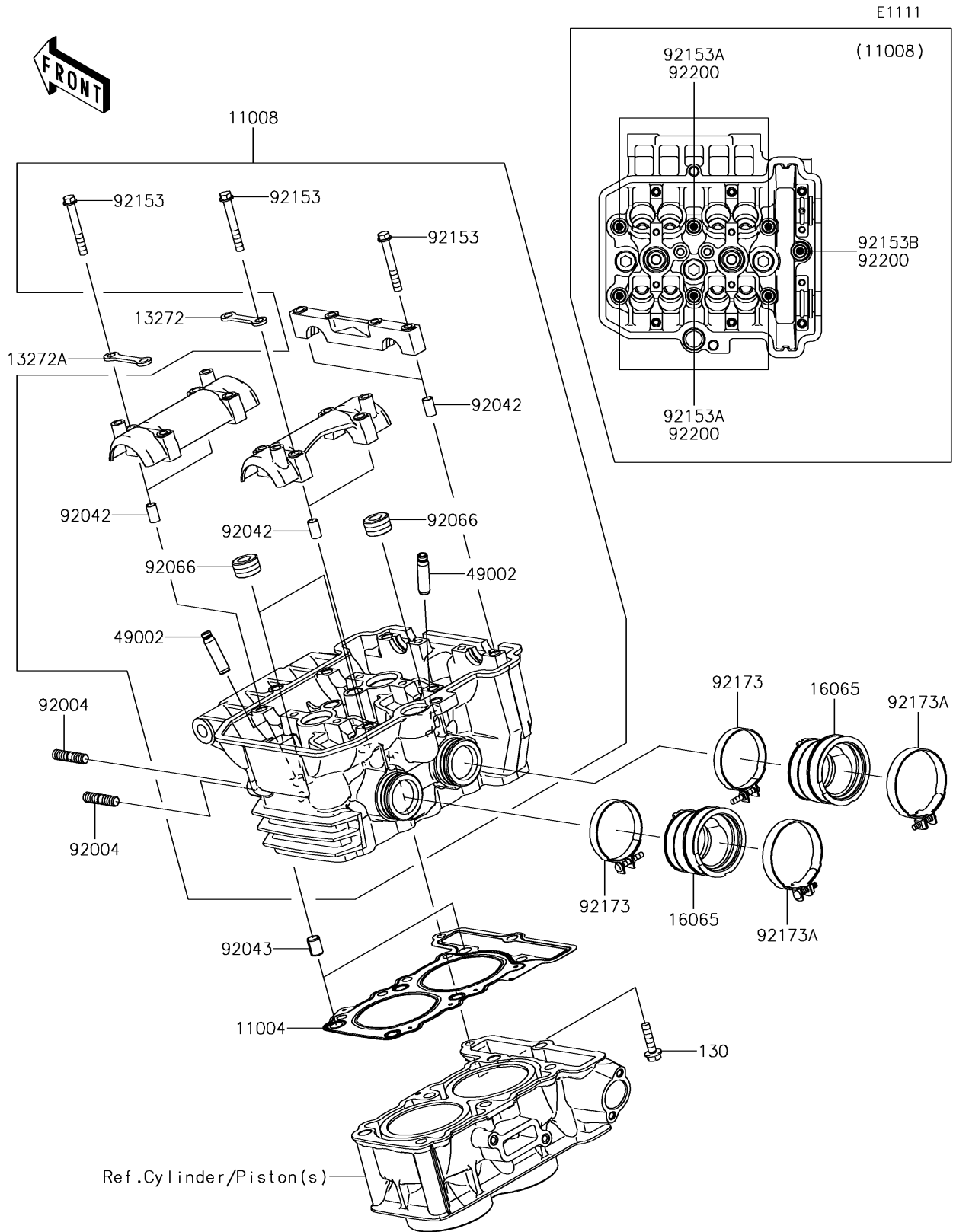

2017 Ninja 300 PARTS LIST

Cylinder Head

ITEM NAME	PART NUMBER	QUANTITY
GASKET-HEAD (Ref # 11004)	11004-0734	1
HEAD-COMP-CYLINDER (Ref # 11008)	11008-0747	1
BOLT-FLANGED,6X25 (Ref # 130)	130CB0625	1
PLATE,IN (Ref # 13272)	13272-0260	2
PLATE,EX (Ref # 13272A)	13272-0261	2
HOLDER-CARBURETOR (Ref # 16065)	16065-0119	2
GUIDE-VALVE (Ref # 49002)	49002-0009	8
STUD,8X22 (Ref # 92004)	92004-0040	4
PIN,DOWEL,6.3X8X14 (Ref # 92042)	92042-007	6
PIN,8.2X10X14 (Ref # 92043)	92043-1264	2
PLUG,PT1/2X12.5 (Ref # 92066)	92066-0002	3
BOLT,6X45 (Ref # 92153)	92153-0339	12
BOLT,SOCKET,8X146 (Ref # 92153A)	92153-1774	6
BOLT,SOCKET,8X115 (Ref # 92153B)	92153-1775	1
CLAMP,47MM (Ref # 92173)	92173-0919	2
CLAMP,53MM (Ref # 92173A)	92173-0956	2
WASHER,8.5X18X1.6 (Ref # 92200)	92200-0860	7