

2008 Prairie 360 4X4 Hardwoods Green HD PARTS DIAGRAM

Meter(s)(CN)

F2530

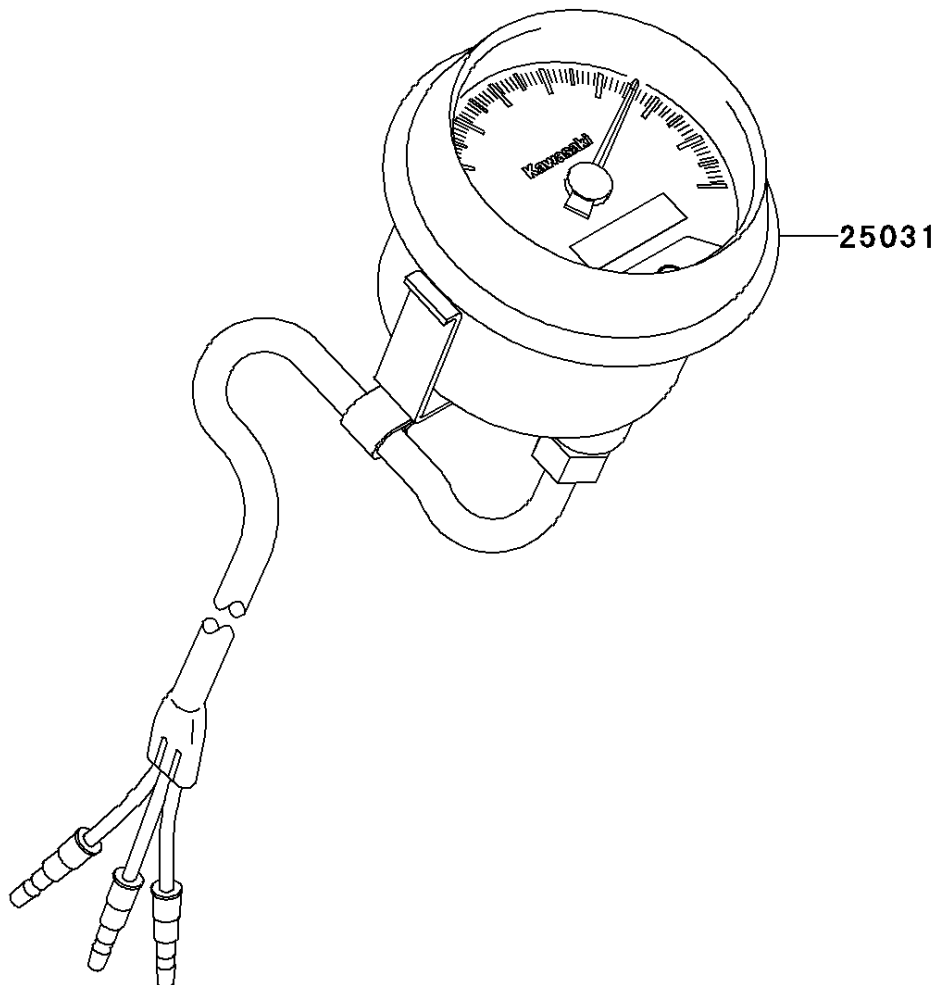

2008 Prairie 360 4X4 Hardwoods Green HD PARTS LIST

Meter(s)(CN)

ITEM NAME	PART NUMBER	QUANTITY
METER-ASSY,KPH (Ref # 25031)	25031-0007	1