

# 2009 Prairie 360 4X4 Hardwoods Green HD PARTS DIAGRAM

Optional Parts(Meter)(US)

F2890

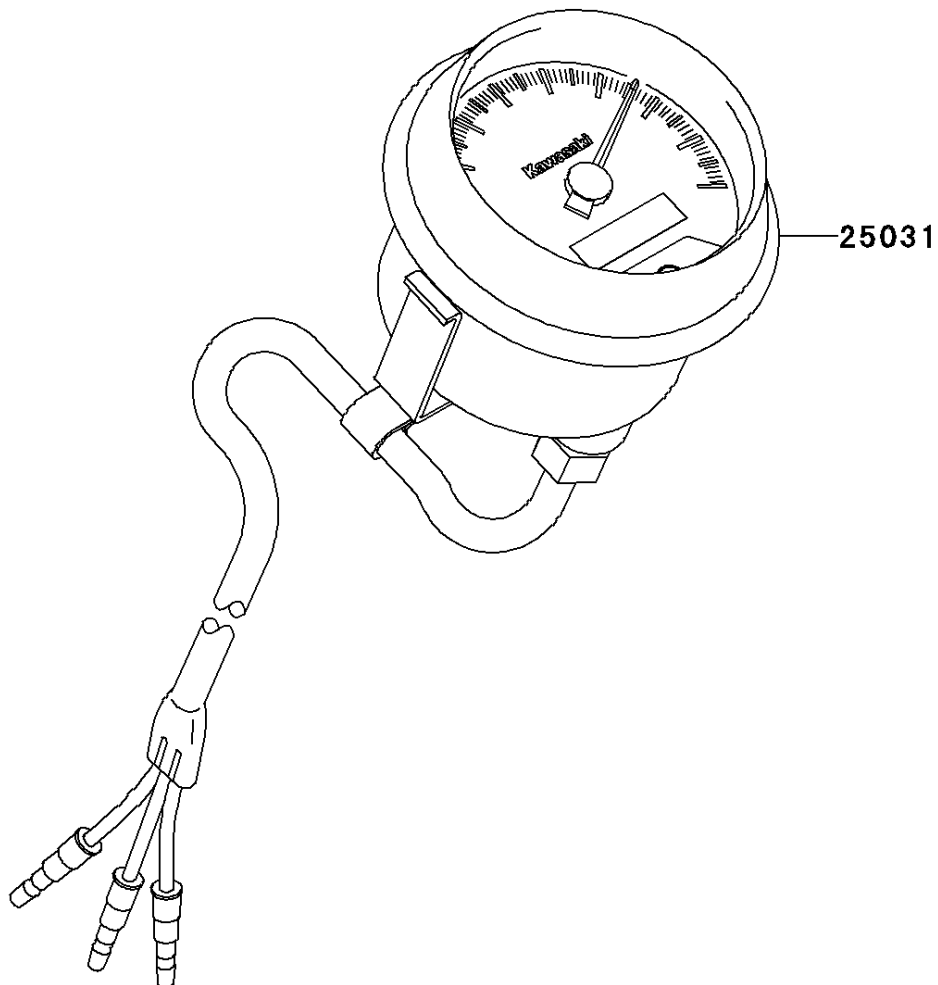

# 2009 Prairie 360 4X4 Hardwoods Green HD PARTS LIST

Optional Parts(Meter)(US)

ITEM NAME	PART NUMBER	QUANTITY
METER-ASSY,MPH (Ref # 25031)	25031-0008	1