

2001 Prairie 400 4X4 PARTS DIAGRAM

Gear Change Mechanism

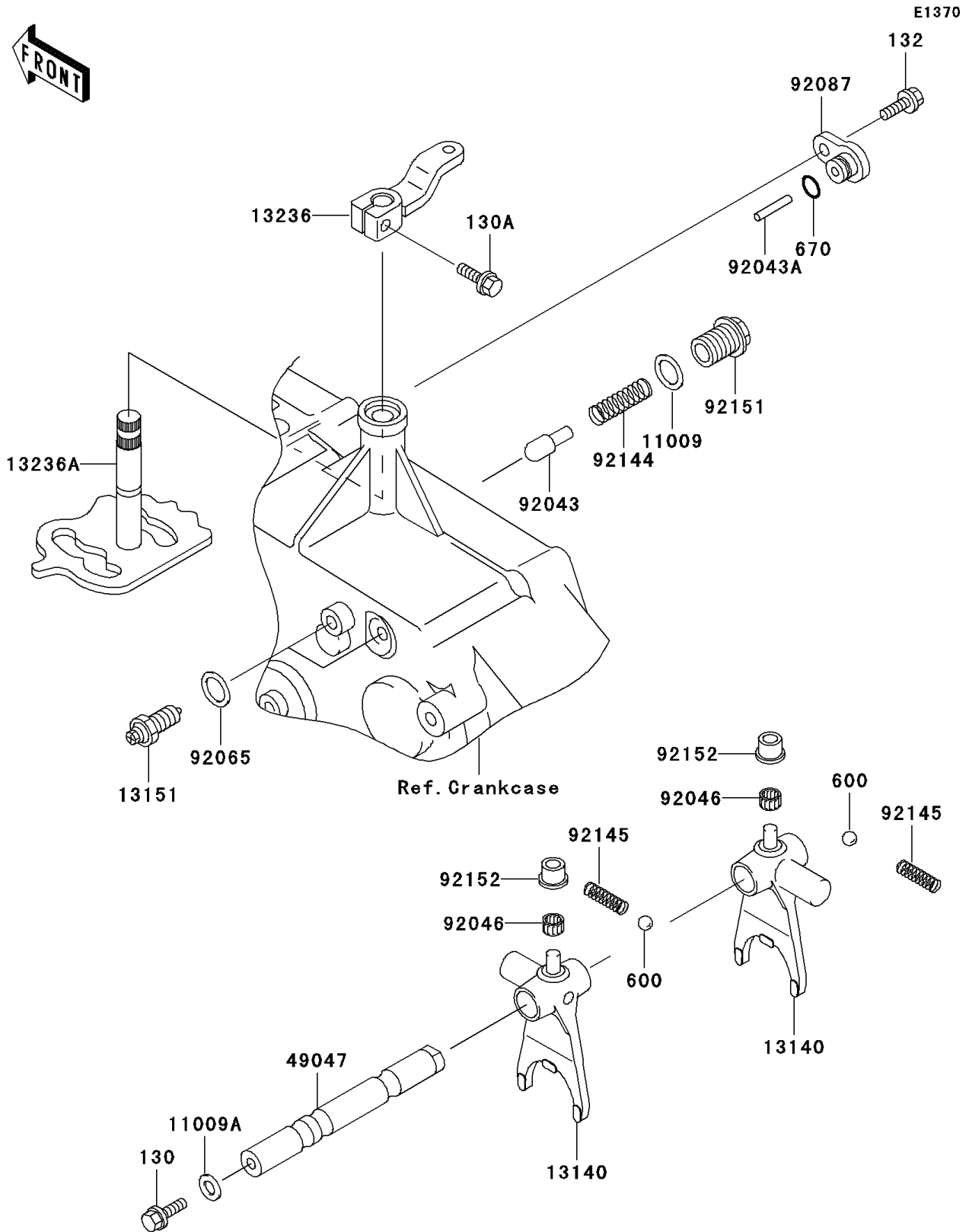

2001 Prairie 400 4X4 PARTS LIST

Gear Change Mechanism

ITEM NAME	PART NUMBER	QUANTITY
BOLT-FLANGED,6X18 (Ref # 130)	130G0618	1
BOLT-FLANGED,6X20 (Ref # 130A)	130T0620	1
BOLT-FLANGED-SMALL,6X14 (Ref # 132)	132J0614	1
BALL-STEEL,11/32" (Ref # 600)	600A1100	2
O RING,10MM (Ref # 670)	670D1510	1
GASKET,15.5X22X1 (Ref # 11009)	11009-1008	1
GASKET,6.5X12X1.0 (Ref # 11009A)	11009-1568	1
FORK-SHIFT (Ref # 13140)	13140-1276	2
SWITCH-COMP,NEUTRAL (Ref # 13151)	13151-1069	2
LEVER-COMP,CHANGE (Ref # 13236)	13236-1318	1
LEVER-COMP,SHIFT (Ref # 13236A)	13236-1323	1
ROD-SHIFT (Ref # 49047)	49047-1098	1
PIN (Ref # 92043)	92043-1578	1
PIN,4X34.8 (Ref # 92043A)	92043-1579	1
BEARING-NEEDLE (Ref # 92046)	92046-1262	2
GASKET,10.5X16X1 (Ref # 92065)	92065-058	2
BUSHING-METER GEAR (Ref # 92087)	92087-1058	1
SPRING,CHANGE LEVER,FR/RR (Ref # 92144)	92144-1702	1
SPRING,L=27.9 (Ref # 92145)	92145-1178	2
BOLT,NEUTRAL POSITION (Ref # 92151)	92151-1388	1
COLLAR (Ref # 92152)	92152-1091	2