

# 2001 Prairie 400 4X4 PARTS DIAGRAM

Crankcase

E1411

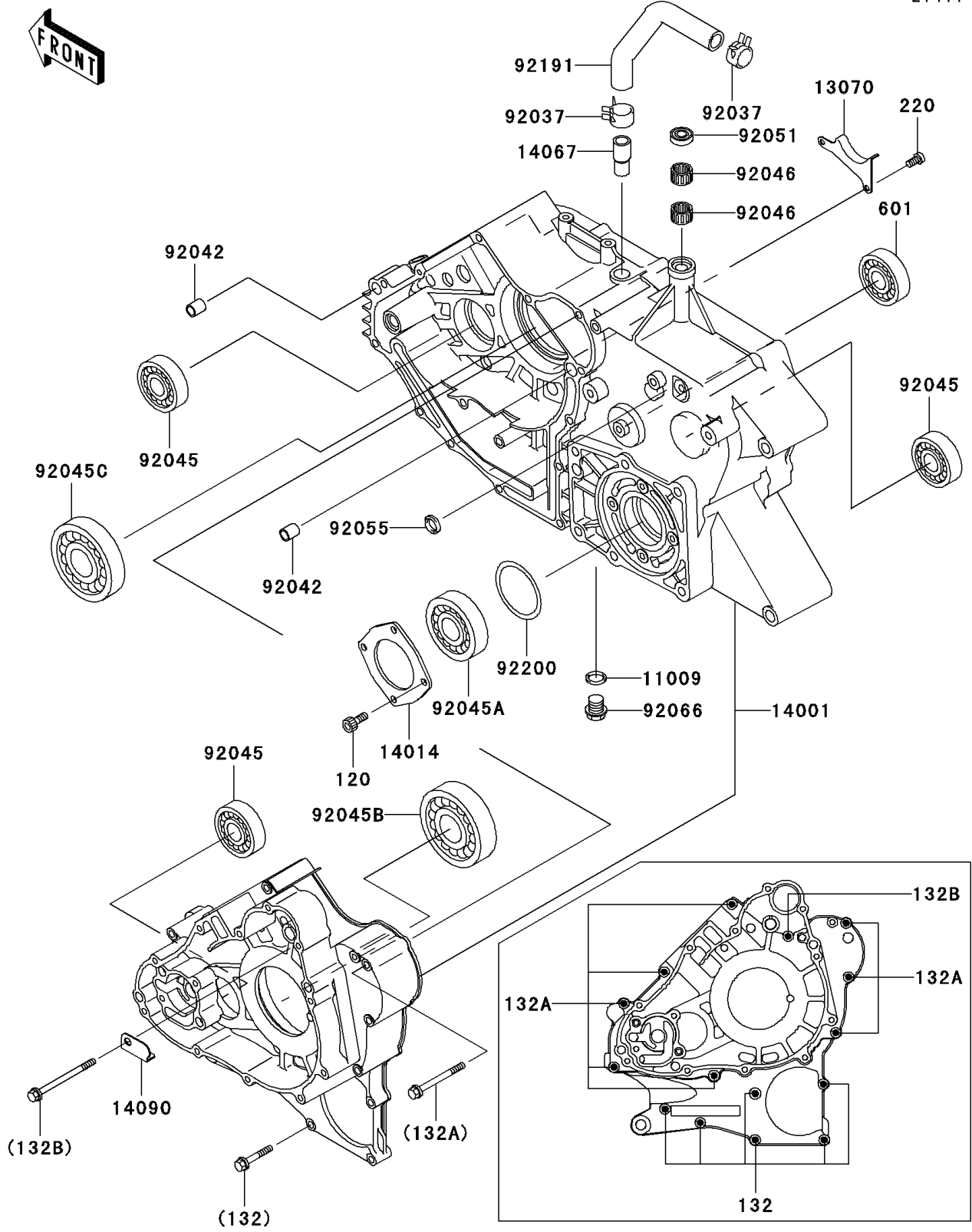

## 2001 Prairie 400 4X4 PARTS LIST

### Crankcase

ITEM NAME	PART NUMBER	QUANTITY
BOLT-SOCKET,6X16 (Ref # 120)	120P0616	4
BOLT-FLANGED-SMALL,6X35 (Ref # 132)	132Y0635	6
BOLT-FLANGED-SMALL,6X65 (Ref # 132A)	132Y0665	8
BOLT-FLANGED-SMALL,6X75 (Ref # 132B)	132Y0675	1
SCREW-PAN-CROS,6X14 (Ref # 220)	220B0614	2
BEARING-BALL (Ref # 601)	601A6204Z	1
GASKET (Ref # 11009)	11009-2175	1
GUIDE,CHAIN (Ref # 13070)	13070-1255	1
SET-CRANKCASE (Ref # 14001)	14001-1245	1
PLATE-POSITION (Ref # 14014)	14014-1108	1
FITTING,BREATHER (Ref # 14067)	14067-006	1
COVER (Ref # 14090)	14090-1710	1
CLAMP (Ref # 92037)	92037-1860	2
PIN,DOWEL,12X14 (Ref # 92042)	92042-031	2
BEARING-BALL,TMB304CCM (Ref # 92045)	92045-1142	3
BEARING-BALL,6305RHR4SH2 (Ref # 92045A)	92045-1254	1
BEARING-BALL,6307SH2-9C4 (Ref # 92045B)	92045-1257	1
BEARING-BALL,6208RSH2-9C3 (Ref # 92045C)	92045-1258	1
BEARING-NEEDLE,HK1312 (Ref # 92046)	92046-1148	2
SEAL-OIL,TB13225.5 (Ref # 92051)	92051-005	1
RING-O,OD=18 (Ref # 92055)	92055-048	1
PLUG,DRAIN (Ref # 92066)	92066-2196	1
TUBE (Ref # 92191)	92191-1114	1
WASHER,50X60.5X0.5 (Ref # 92200)	92200-1106	1