

2002 Prairie 400 4X4 PARTS DIAGRAM

Engine Cover(s)

E1431

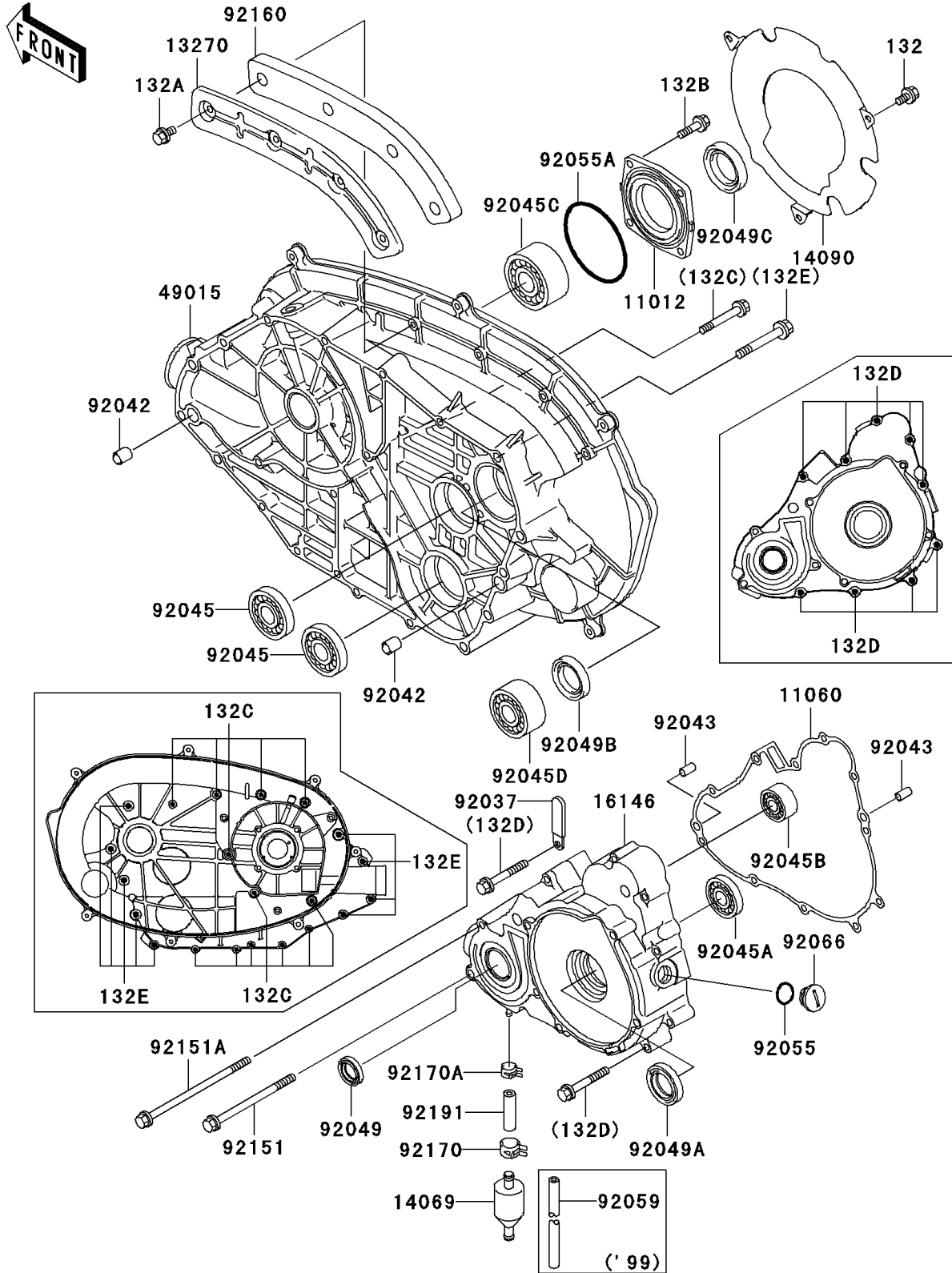

2002 Prairie 400 4X4 PARTS LIST

Engine Cover(s)

ITEM NAME	PART NUMBER	QUANTITY
BOLT-FLANGED-SMALL,6X12 (Ref # 132)	132G0612	3
BOLT-FLANGED-SMALL,6X12 (Ref # 132A)	132Y0612	4
BOLT-FLANGED-SMALL,6X20 (Ref # 132B)	132Y0620	4
BOLT-FLANGED-SMALL,6X35 (Ref # 132C)	132Y0635	12
BOLT-FLANGED-SMALL,6X40 (Ref # 132D)	132Y0640	9
BOLT-FLANGED-SMALL,8X40 (Ref # 132E)	132Y0840	9
CAP (Ref # 11012)	11012-1982	1
GASKET,GENERATOR COVER (Ref # 11060)	11060-1729	1
PLATE (Ref # 13270)	13270-1737	1
BREATHER (Ref # 14069)	14069-1051	1
COVER (Ref # 14090)	14090-1960	1
COVER-ASSY,GENERATOR (Ref # 16146)	16146-1206	1
COVER-CRANKCASE (Ref # 49015)	49015-1056	1
CLAMP,L=45 (Ref # 92037)	92037-1539	1
PIN,DOWEL,12X14 (Ref # 92042)	92042-031	2
PIN,6.2X8X14 (Ref # 92043)	92043-1263	2
BEARING-BALL,TMB304CCM (Ref # 92045)	92045-1142	2
BEARING-BALL (Ref # 92045A)	92045-1178	1
BEARING-BALL,5201 (Ref # 92045B)	92045-1327	1
BEARING-BALL,5207C2 (Ref # 92045C)	92045-1328	1
BEARING-BALL,5206 (Ref # 92045D)	92045-1329	1
SEAL-OIL,SC12 28.555 (Ref # 92049)	92049-1259	1
SEAL-OIL (Ref # 92049A)	92049-1386	1
SEAL-OIL,TC30458 (Ref # 92049B)	92049-1451	1
SEAL-OIL,TC 35X50X8 (Ref # 92049C)	92049-1452	1
RING-O,20X2 (Ref # 92055)	92055-1146	1
RING-O,79.5MM (Ref # 92055A)	92055-1230	1
PLUG,COVER (Ref # 92066)	92066-1163	1
BOLT,6X85 (Ref # 92151)	92151-1140	1

2002 Prairie 400 4X4 PARTS LIST

Engine Cover(s)

ITEM NAME	PART NUMBER	QUANTITY
BOLT,6X110 (Ref # 92151A)	92151-1141	1
DAMPER (Ref # 92160)	92160-1793	1
CLAMP (Ref # 92170)	92170-1492	1
CLAMP (Ref # 92170A)	92170-1493	1
TUBE (Ref # 92191)	92191-1427	1