

2018 Z900 PARTS DIAGRAM

Oil Pan

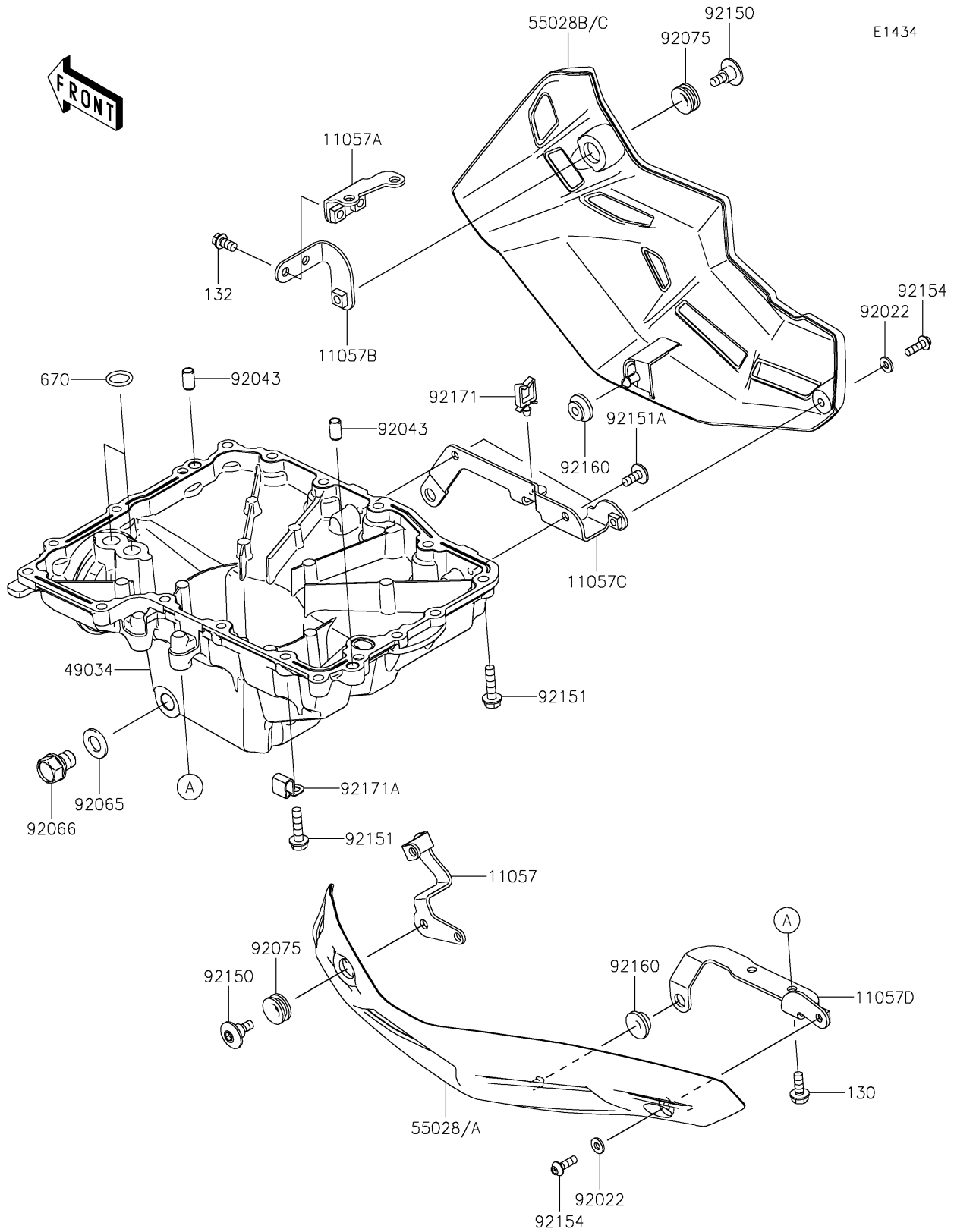

2018 Z900 PARTS LIST

Oil Pan

ITEM NAME	PART NUMBER	QUANTITY
BRACKET,LWR COWLING,LH,FR (Ref # 11057)	11057-0291	1
BRACKET,LWR COWLING,RH,FR (Ref # 11057A)	11057-0293	1
BRACKET,LWR COWLING,RH,FR (Ref # 11057B)	11057-0294	1
BRACKET,LWR COWLING,RH,RR (Ref # 11057C)	11057-0295	1
BRACKET,LWR COWLING,LH,RR (Ref # 11057D)	11057-0874	1
BOLT-FLANGED,6X16 (Ref # 130)	130CC0616	2
BOLT-FLANGED-SMALL,6X12 (Ref # 132)	132BA0612	2
PAN-OIL (Ref # 49034)	49034-0049	1
COWLING,LWR,LH,M.F.S.BLACK (Ref # 55028)	55028-5482-739	1
COWLING,LWR,RH,M.F.S.BLACK (Ref # 55028B)	55028-5483-739	1
O RING,14MM (Ref # 670)	670D2014	2
WASHER,NYLON,5.3X11.5X1.5 (Ref # 92022)	92022-1521	2
PIN,6.2X8X14 (Ref # 92043)	92043-1263	2
GASKET,12X22X2 (Ref # 92065)	92065-097	1
PLUG,12X15 (Ref # 92066)	92066-0079	1
DAMPER (Ref # 92075)	92075-1634	2
BOLT,SOCKET,6MM (Ref # 92150)	92150-1154	2
BOLT,FLANGED,6X25 (Ref # 92151)	92151-1225	18
BOLT,SOCKET,6X14 (Ref # 92151A)	92151-1654	2
BOLT,SOCKET,5X16 (Ref # 92154)	92154-0287	2
DAMPER (Ref # 92160)	92160-1613	2
CLAMP (Ref # 92171)	92171-0290	1
CLAMP (Ref # 92171A)	92171-0534	1