

2000 Prairie 400 PARTS DIAGRAM

Cylinder/Piston(s)

E1120

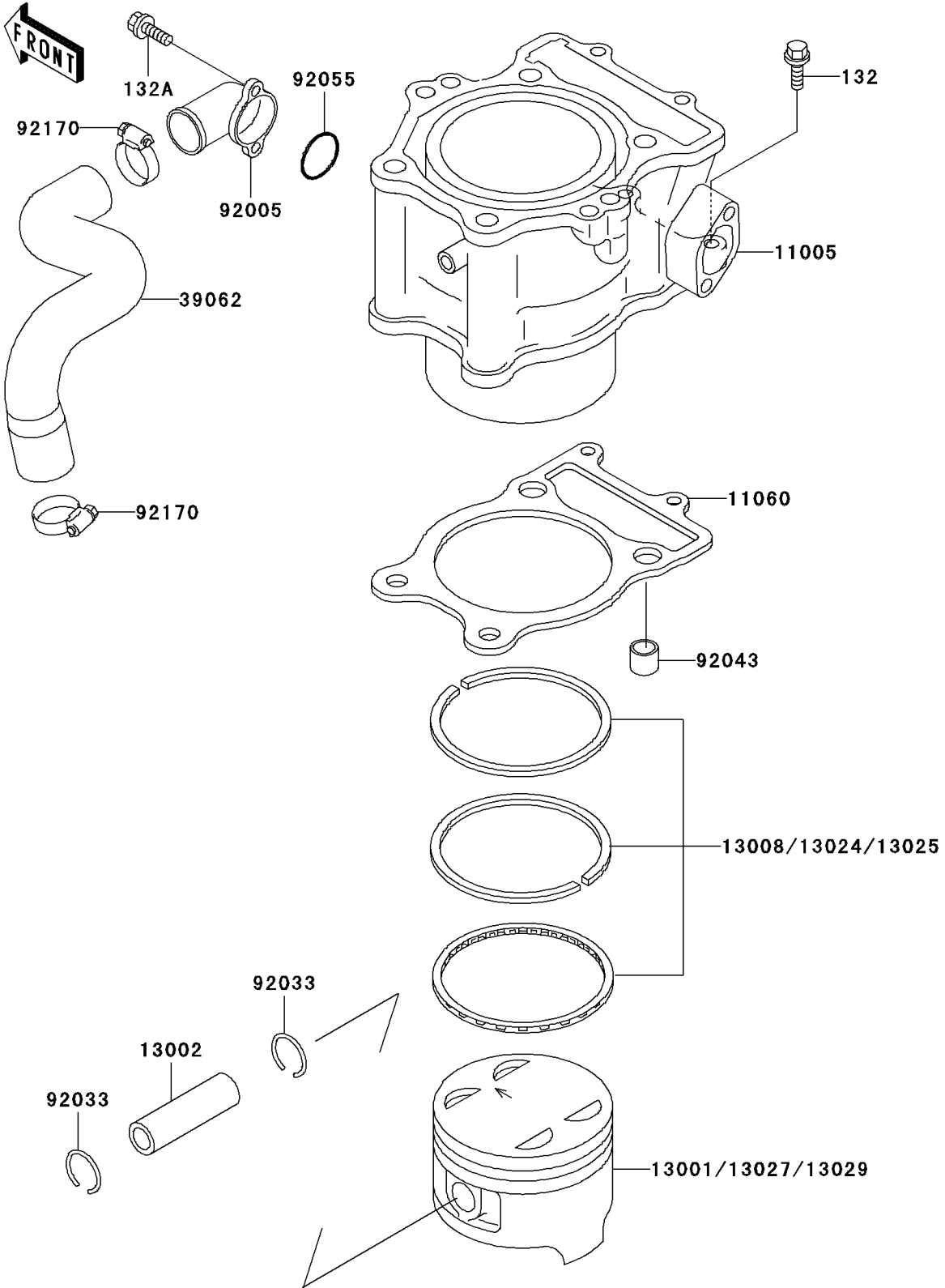

2000 Prairie 400 PARTS LIST

Cylinder/Piston(s)

ITEM NAME	PART NUMBER	QUANTITY
BOLT-FLANGED-SMALL,6X25 (Ref # 132)	132G0625	2
BOLT-FLANGED-SMALL,6X16 (Ref # 132A)	132J0616	2
CYLINDER-ENGINE (Ref # 11005)	11005-1673	1
GASKET,CYLINDER BASE (Ref # 11060)	11060-1205	1
PISTON-ENGINE,STD (Ref # 13001)	13001-1521	1
PIN-PISTON (Ref # 13002)	13002-1056	1
RING-SET-PISTON,STD (Ref # 13008)	13008-1142	1
RING-SET-PISTON LL,O/S 1.00 (Ref # 13024)	13024-1090	1
RING-SET-PISTON L,O/S 0.50 (Ref # 13025)	13025-1114	1
PISTON-ENGINE LL,O/S 1.00 (Ref # 13027)	13027-1201	1
PISTON-ENGINE L,O/S 0.50 (Ref # 13029)	13029-1258	1
HOSE-COOLING (Ref # 39062)	39062-1674	1
FITTING,CYLINDER (Ref # 92005)	92005-1145	1
RING-SNAP (Ref # 92033)	92033-1188	2
PIN,11X14X12.3 (Ref # 92043)	92043-1266	2
RING-O (Ref # 92055)	92055-091	1
CLAMP (Ref # 92170)	92170-1497	2