

# 2000 Prairie 400 PARTS DIAGRAM

Optional Parts(Meter(s))

F2890A

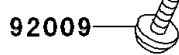
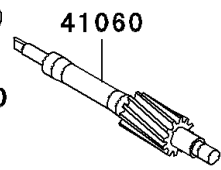
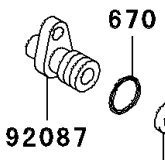
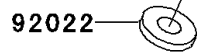
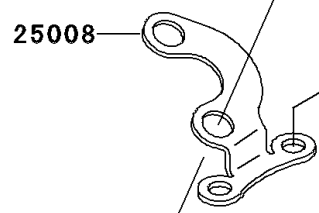
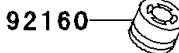
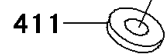
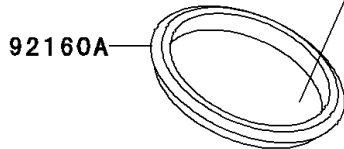
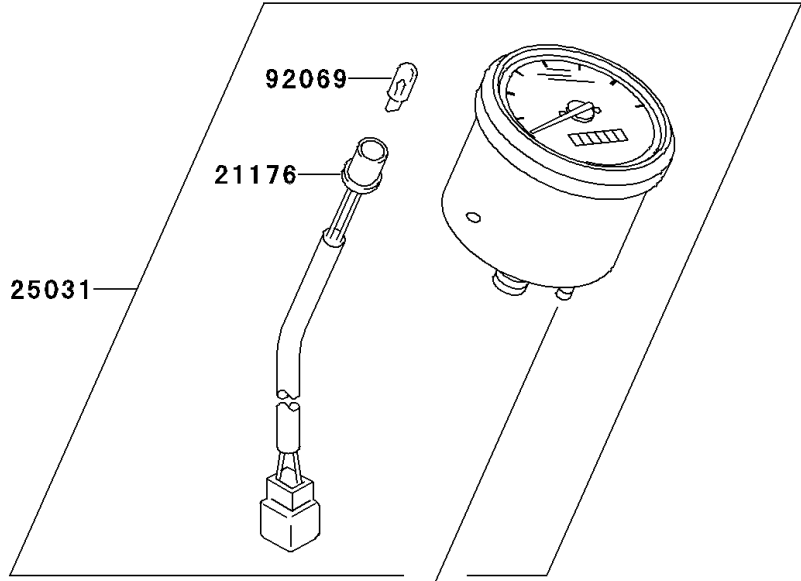
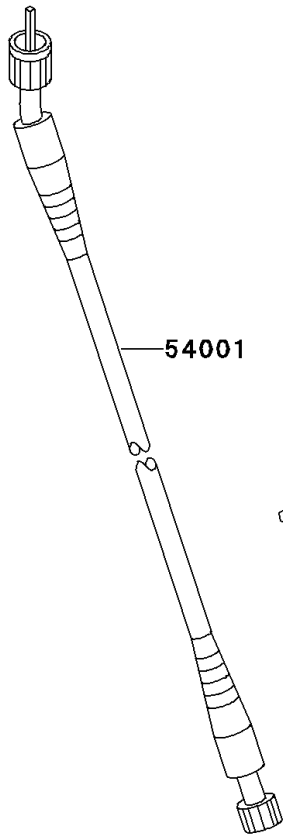

## 2000 Prairie 400 PARTS LIST

### Optional Parts(Meter(s))

ITEM NAME	PART NUMBER	QUANTITY
BOLT-FLANGED,8X12 (Ref # 130)	130J0812	2
WASHER-PLAIN-SMALL,5MM (Ref # 410)	410B0500	1
WASHER-PLAIN-SMALL,6MM (Ref # 410A)	410B0600	1
CORD ASSY,SPEEDOMETER (Ref # 21176)	21176-1059	1
BRACKET-METER (Ref # 25008)	25008-1221	1
METER-ASSY,MPH (Ref # 25031)	25031-1080	1
GEAR-METER SCREW (Ref # 41060)	41060-1157	1
CABLE-SPEEDMETER (Ref # 54001)	54001-1232	1
SCREW,5X12 (Ref # 92009)	92009-3740	2
WASHER,6.5X16X1.0 (Ref # 92022)	92022-1093	2
BULB,12V 1.7W,T10 (Ref # 92069)	92069-1059	1
BAND,L=186 (Ref # 92072)	92072-056	1
BUSHING-METER GEAR (Ref # 92087)	92087-1057	1
DAMPER (Ref # 92160)	92160-1461	2
DAMPER,SPEEDOMETER (Ref # 92160A)	92160-1959	1
WASHER-PLAIN,8MM (Ref # 411)	411B0800	2
O RING,12MM (Ref # 670)	670B2012	1