

# 2002 Prairie 400 PARTS DIAGRAM

Optional Parts(Meter(s))

F2890A

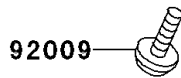
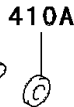
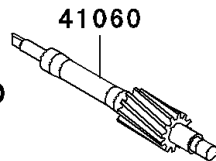
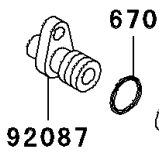
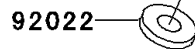
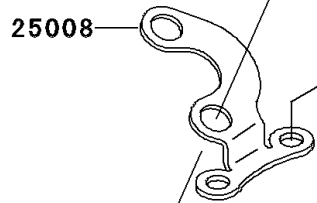
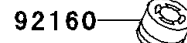
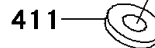
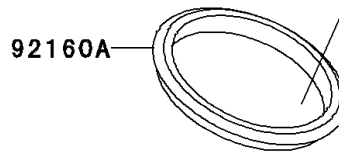
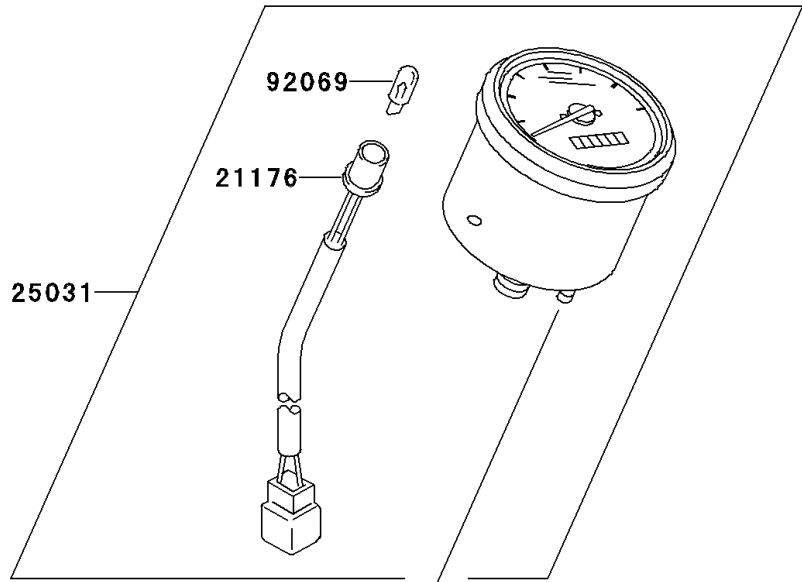
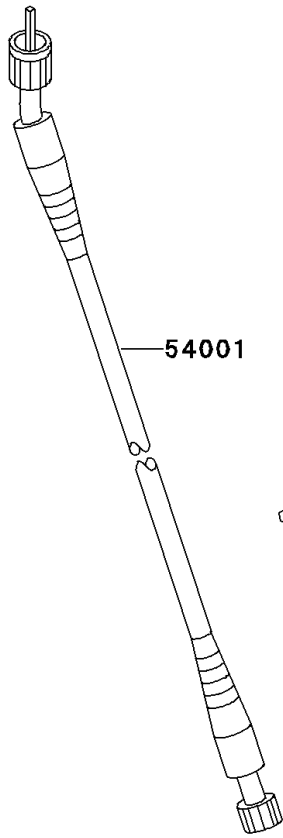

## 2002 Prairie 400 PARTS LIST

### Optional Parts(Meter(s))

| ITEM NAME                           | PART NUMBER | QUANTITY |
|-------------------------------------|-------------|----------|
| BOLT-FLANGED,8X12 (Ref # 130)       | 130J0812    | 2        |
| WASHER-PLAIN-SMALL,5MM (Ref # 410)  | 410B0500    | 1        |
| WASHER-PLAIN-SMALL,6MM (Ref # 410A) | 410B0600    | 1        |
| CORD ASSY,SPEEDOMETER (Ref # 21176) | 21176-1059  | 1        |
| BRACKET-METER (Ref # 25008)         | 25008-1221  | 1        |
| METER-ASSY,MPH (Ref # 25031)        | 25031-1080  | 1        |
| GEAR-METER SCREW (Ref # 41060)      | 41060-1157  | 1        |
| CABLE-SPEEDMETER (Ref # 54001)      | 54001-1232  | 1        |
| SCREW,5X12 (Ref # 92009)            | 92009-3740  | 2        |
| WASHER,6.5X16X1.0 (Ref # 92022)     | 92022-1093  | 2        |
| BULB,12V 1.7W,T10 (Ref # 92069)     | 92069-1059  | 1        |
| BAND,L=186 (Ref # 92072)            | 92072-056   | 1        |
| BUSHING-METER GEAR (Ref # 92087)    | 92087-1057  | 1        |
| DAMPER (Ref # 92160)                | 92160-1461  | 2        |
| DAMPER,SPEEDOMETER (Ref # 92160A)   | 92160-1959  | 1        |
| WASHER-PLAIN,8MM (Ref # 411)        | 411B0800    | 2        |
| O RING,12MM (Ref # 670)             | 670B2012    | 1        |