

# 2019 CONCOURS®14 ABS PARTS DIAGRAM

Rear Wheel/Chain

F2240

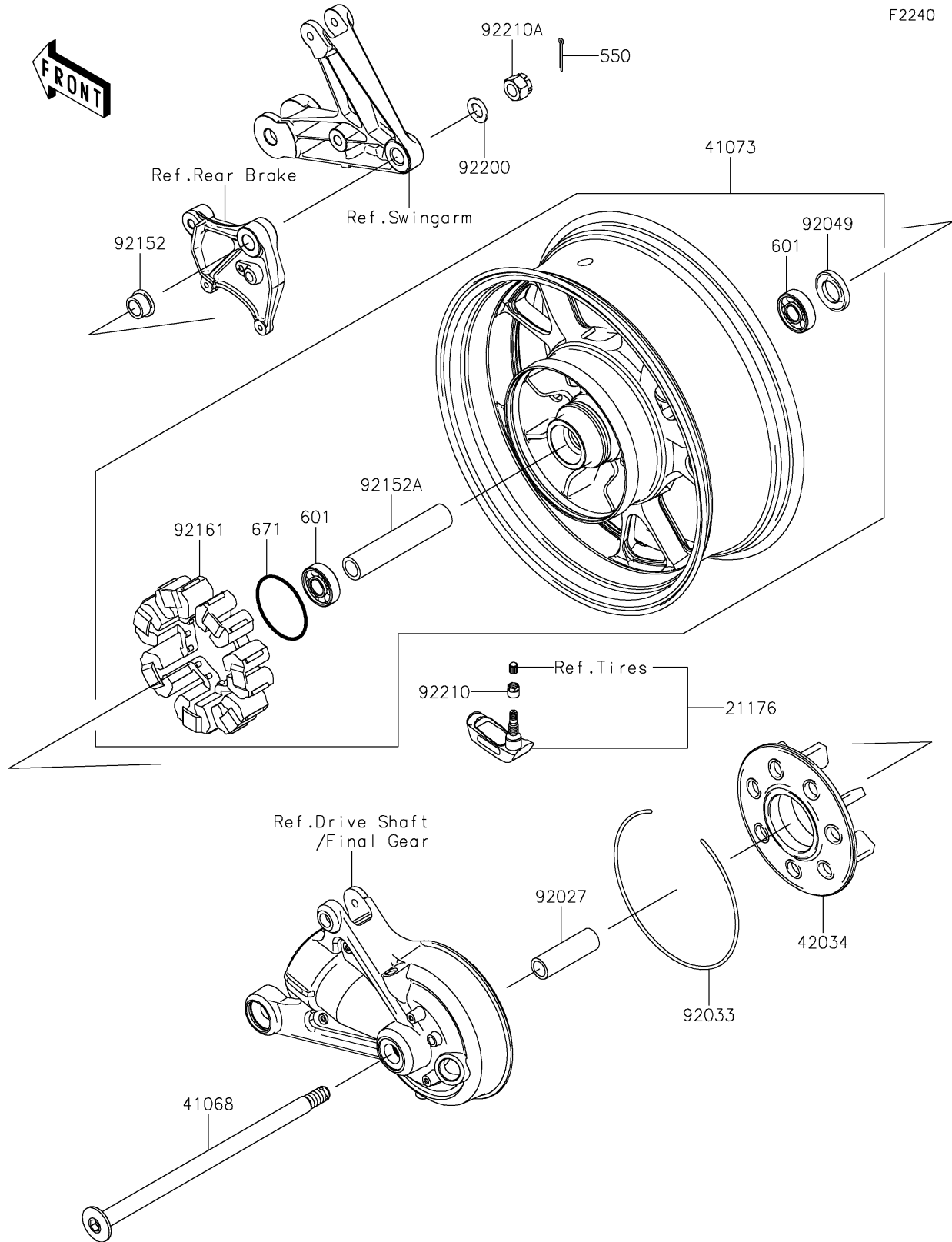

## 2019 CONCOURS®14 ABS PARTS LIST

### Rear Wheel/Chain

ITEM NAME	PART NUMBER	QUANTITY
SENSOR,TPMS 315MHZ (Ref # 21176)	21176-0748	1
AXLE,RR,20X390 (Ref # 41068)	41068-0605	1
WHEEL-ASSY,RR,G.BLACK (Ref # 41073)	41073-0594-18F	1
COUPLING,RR HUB (Ref # 42034)	42034-0002	1
PIN-COTTER,4.0X40 (Ref # 550)	550AA4040	1
BEARING-BALL,#6304UUC3 (Ref # 601)	601B6304UU	2
O RING,80MM (Ref # 671)	671B2580	1
COLLAR,20.2X28X89 (Ref # 92027)	92027-1553	1
RING-SNAP,220MM (Ref # 92033)	92033-0012	1
SEAL-OIL,27X52X5 (Ref # 92049)	92049-0723	1
COLLAR,RR AXLE,RH,L=17 (Ref # 92152)	92152-0105	1
COLLAR,RR HUB,L=151 (Ref # 92152A)	92152-0494	1
DAMPER,SHOCK,RR HUB (Ref # 92161)	92161-0409	1
WASHER,19X32X2.6 (Ref # 92200)	92200-1489	1
NUT (Ref # 92210)	92210-0836	1
NUT,CASTLE,18MM (Ref # 92210A)	92210-1134	1