

2017 NINJA® ZX™ -6R ABS PARTS DIAGRAM

Crankcase Bolt Pattern

E1412

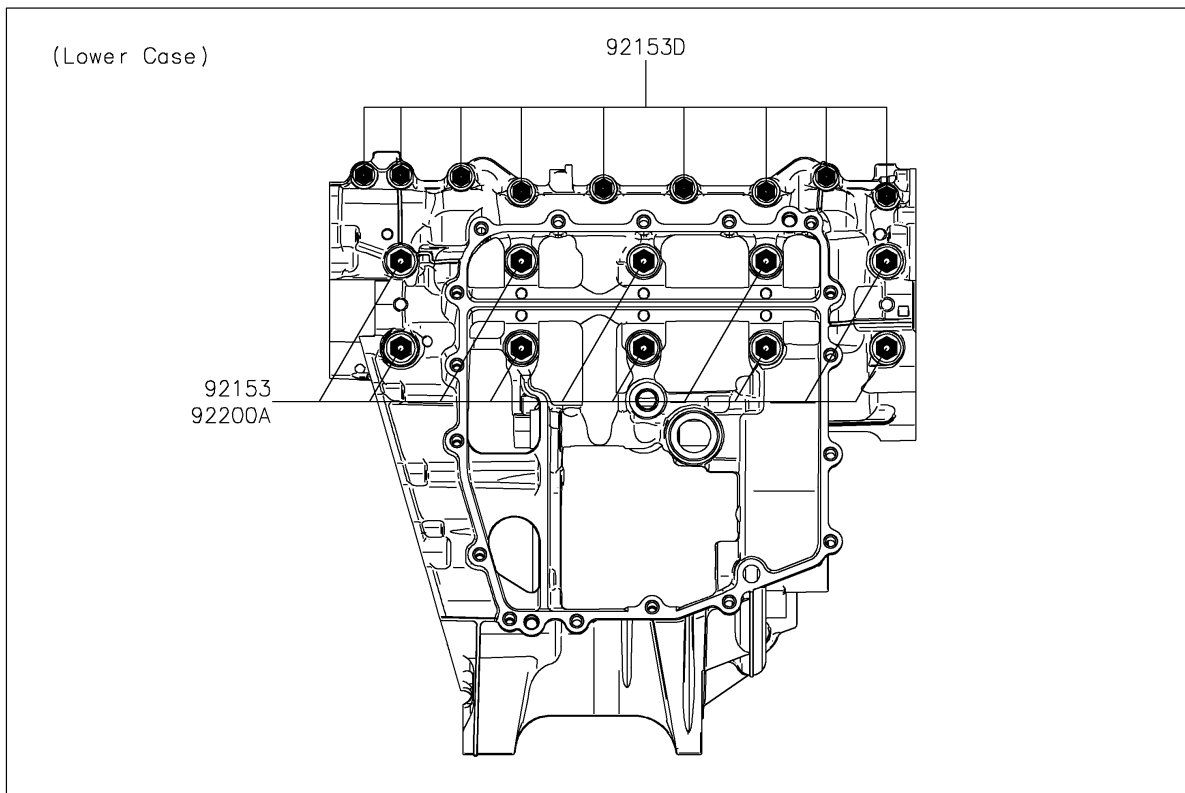
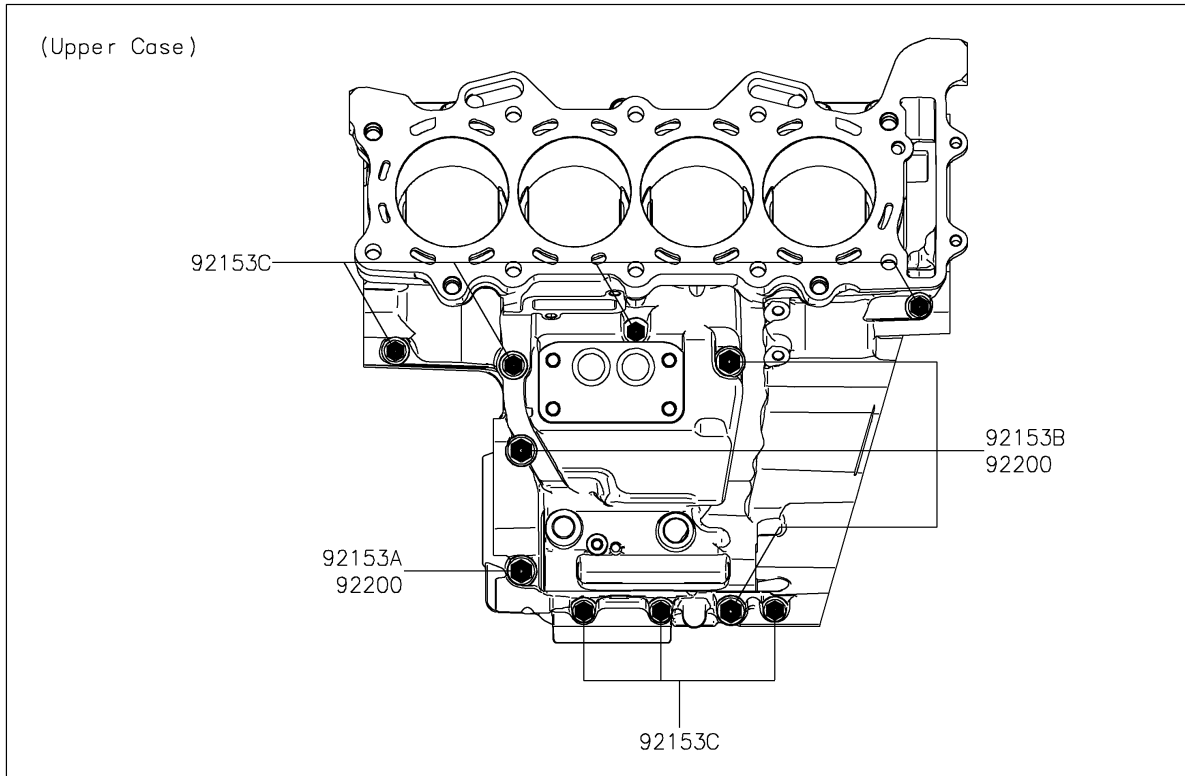

2017 NINJA® ZX™-6R ABS PARTS LIST

Crankcase Bolt Pattern

ITEM NAME	PART NUMBER	QUANTITY
BOLT,FLANGED,8X95 (Ref # 92153)	92153-1631	10
BOLT,FLANGED,8X90 (Ref # 92153A)	92153-1632	1
BOLT,FLANGED,8X75 (Ref # 92153B)	92153-1633	3
BOLT,FLANGED,6X68 (Ref # 92153C)	92153-1637	7
BOLT,FLANGED,6X50 (Ref # 92153D)	92153-1638	9
WASHER,8.2X16X1.6 (Ref # 92200)	92200-0047	4
WASHER,8.5X18X3.0 (Ref # 92200A)	92200-0153	10