

2019 BRUTE FORCE® 750 4x4i EPS PARTS DIAGRAM

Carrier(s)

F2520

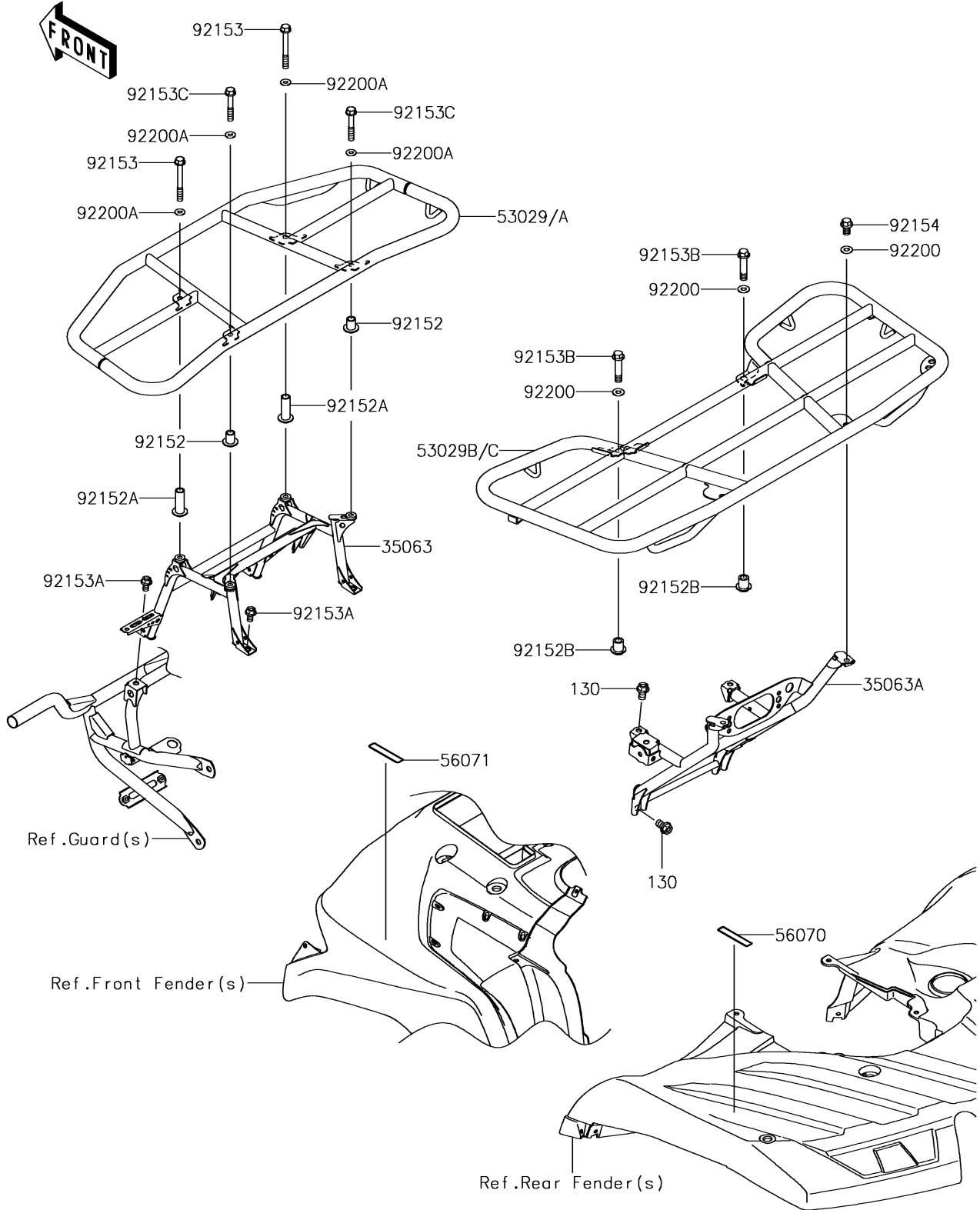

2019 BRUTE FORCE® 750 4x4i EPS PARTS LIST

Carrier(s)

ITEM NAME	PART NUMBER	QUANTITY
BOLT-FLANGED,10X16 (Ref # 130)	130CA1016	4
STAY,FR CARRIER (Ref # 35063)	35063-0826	1
STAY,RR CARRIER,T.BLACK (Ref # 35063A)	35063-0946-388	1
CARRIER,FR,T.BLACK (Ref # 53029A)	53029-0093-388	1
CARRIER,RR,T.BLACK (Ref # 53029C)	53029-0094-388	1
LABEL-WARNING,MAXIMUM LOAD (Ref # 56070)	56070-0041	1
LABEL-WARNING,MAX LOAD 40KG (Ref # 56071)	56071-0200	1
COLLAR (Ref # 92152)	92152-0823	2
COLLAR (Ref # 92152A)	92152-0896	2
COLLAR (Ref # 92152B)	92152-0897	2
BOLT,FLANGED,8X70 (Ref # 92153)	92153-0748	2
BOLT,FLANGED,8X14 (Ref # 92153A)	92153-0931	4
BOLT,FLANGED,10X44 (Ref # 92153B)	92153-1374	2
BOLT,FLANGED,8X50 (Ref # 92153C)	92153-1755	2
BOLT,FLANGED,10X16 (Ref # 92154)	92154-0916	2
WASHER,10.3X23X1.6 (Ref # 92200)	92200-0724	4
WASHER,8.5X20X1.6 (Ref # 92200A)	92200-0774	4