

2019 KLX®140 PARTS DIAGRAM

Chassis Electrical Equipment

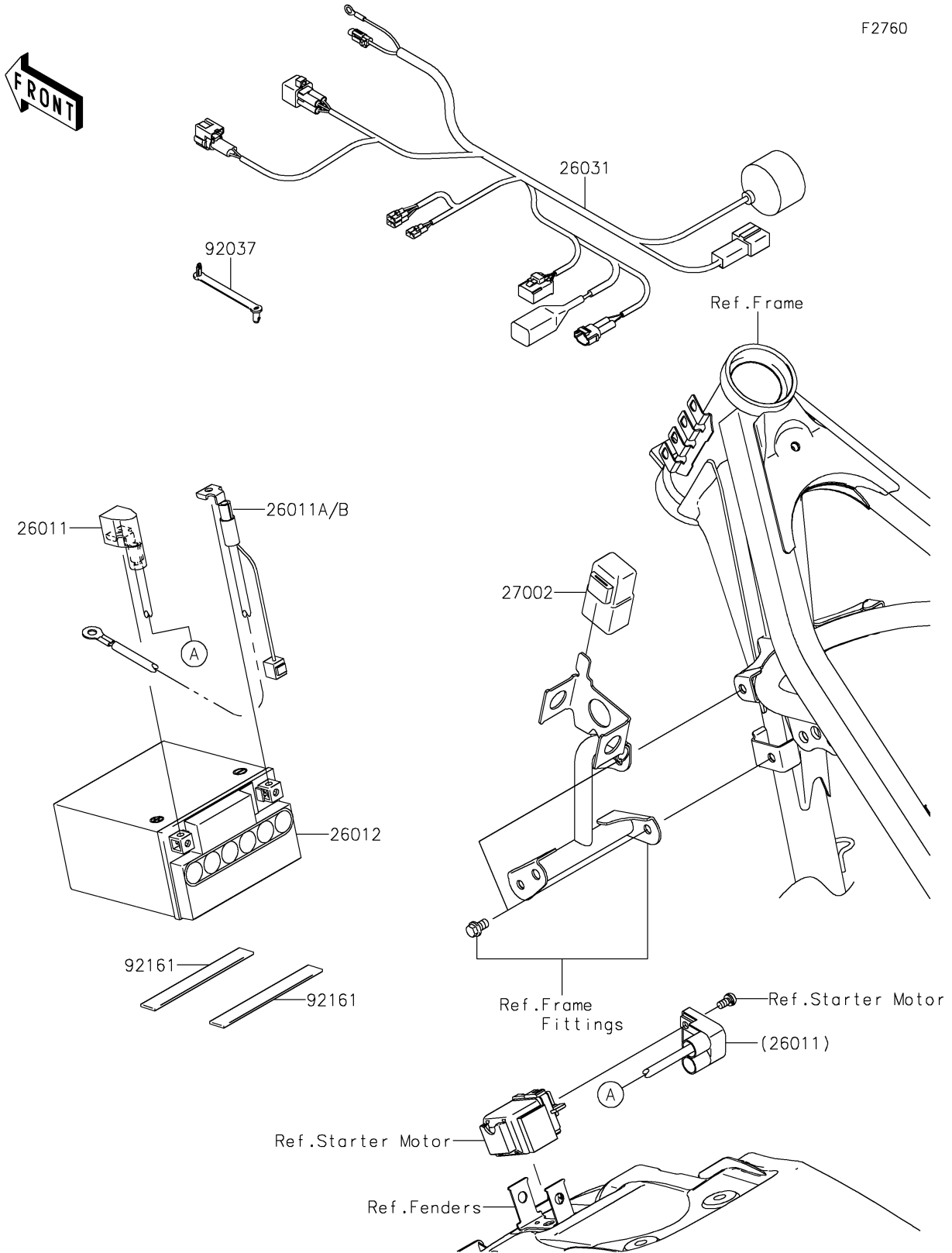

2019 KLX®140 PARTS LIST

Chassis Electrical Equipment

ITEM NAME	PART NUMBER	QUANTITY
WIRE-LEAD,BATTERY(+) (Ref # 26011)	26011-0153	1
WIRE-LEAD,BATTERY(-) (Ref # 26011B)	26011-0969	1
BATTERY,FTX7L-BS,12V 6AH (Ref # 26012)	26012-0683	1
HARNESS,MAIN (Ref # 26031)	26031-2228	1
RELAY-ASSY (Ref # 27002)	27002-1086	1
CLAMP,SPEED,L=58 (Ref # 92037)	92037-1163	5
DAMPER (Ref # 92161)	92161-0543	2