

2020 KLX®140G PARTS DIAGRAM

Crankcase

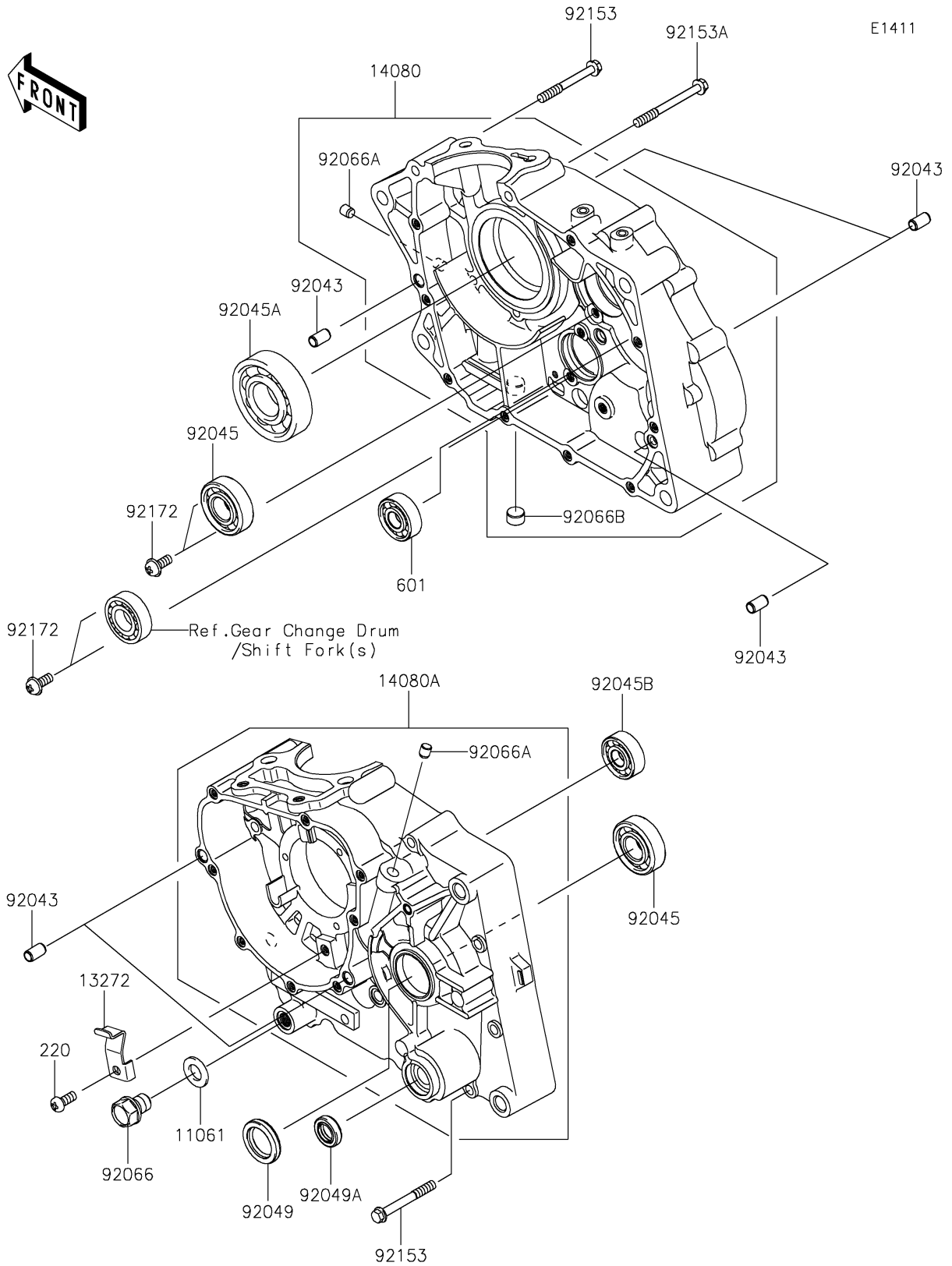

2020 KLX®140G PARTS LIST

Crankcase

ITEM NAME	PART NUMBER	QUANTITY
GASKET,DRAIN PLUG (Ref # 11061)	11061-0421	1
PLATE (Ref # 13272)	13272-1384	1
CRANKCASE,RH (Ref # 14080)	14080-0251	1
CRANKCASE,LH (Ref # 14080A)	14080-0295	1
SCREW-PAN-CROS,6X14 (Ref # 220)	220AA0614	1
BEARING-BALL (Ref # 601)	601A6201	1
PIN,6.2X8X14 (Ref # 92043)	92043-1263	6
BEARING-BALL,#6203C2 (Ref # 92045)	92045-0745	2
BEARING-BALL,6305JR2C3 (Ref # 92045A)	92045-1120	1
BEARING-BALL,6201ZC3/5C (Ref # 92045B)	92045-1308	1
SEAL-OIL (Ref # 92049)	92049-0011	1
SEAL-OIL,13X22X5.5 (Ref # 92049A)	92049-0141	1
PLUG,OIL DRAIN,12X15 (Ref # 92066)	92066-0753	1
PLUG,OIL LINE,7.2X8 (Ref # 92066A)	92066-1012	2
PLUG (Ref # 92066B)	92066-1110	1
BOLT,6X50 (Ref # 92153)	92153-1145	10
BOLT,6X60 (Ref # 92153A)	92153-1146	1
SCREW,6X14 (Ref # 92172)	92172-1062	4