

2020 KLX®140G PARTS DIAGRAM

Suspension/Shock Absorber

F2151

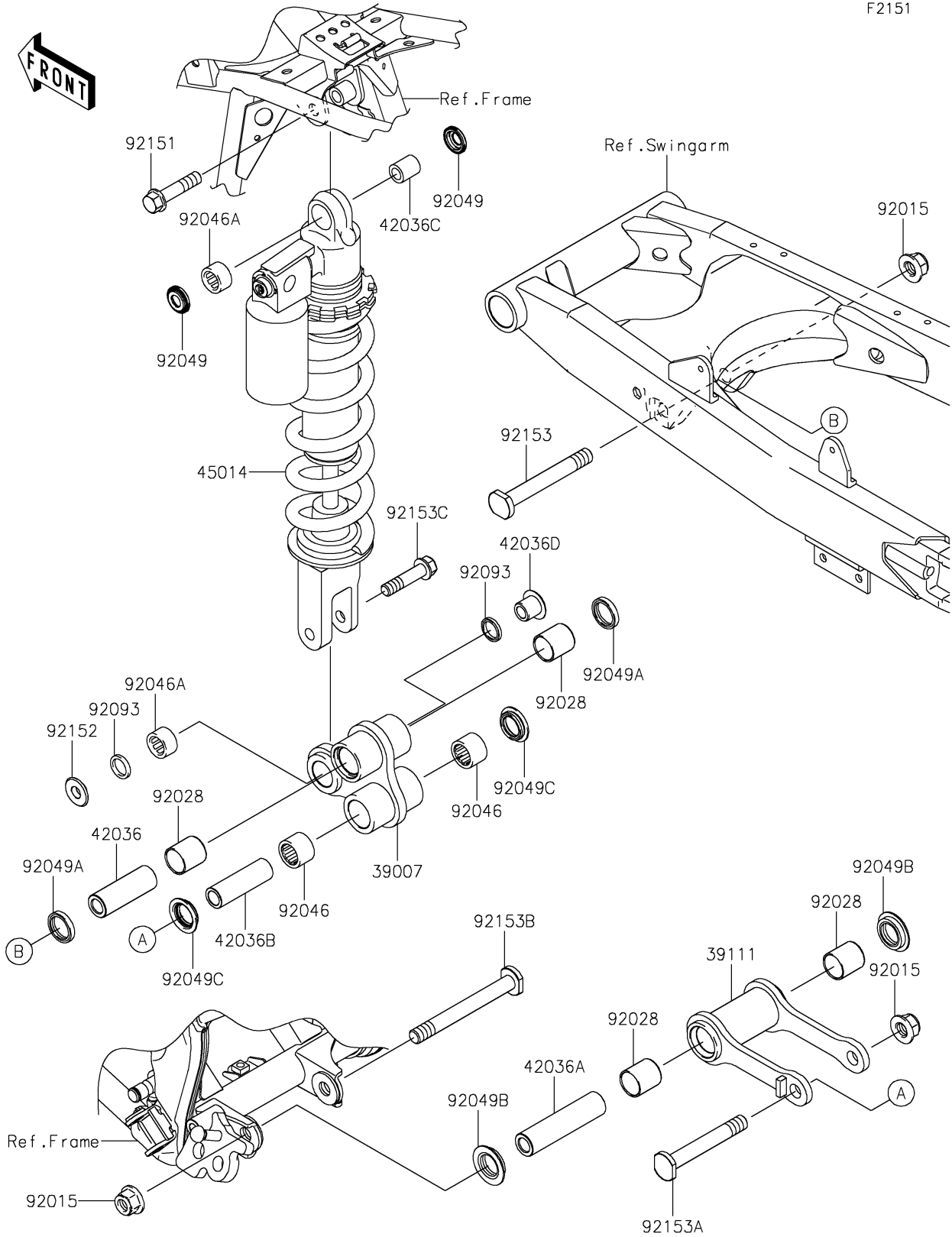

2020 KLX®140G PARTS LIST

Suspension/Shock Absorber

ITEM NAME	PART NUMBER	QUANTITY
ARM-SUSP,UNI TRAK,P.SILVER (Ref # 39007)	39007-0141-458	1
ROD-TIE,SUSPENSION,P.SILVER (Ref # 39111)	39111-0062-458	1
SLEEVE,12.1X20X58 (Ref # 42036)	42036-0046	1
SLEEVE,12.1X20X82.6 (Ref # 42036A)	42036-0047	1
SLEEVE,12.1X18X58 (Ref # 42036B)	42036-0058	1
SLEEVE,10X16X19 (Ref # 42036C)	42036-1248	1
SLEEVE (Ref # 42036D)	42036-1351	1
SHOCKABSORBER,BLACK (Ref # 45014)	45014-0545-10	1
NUT,LOCK,FLANGED,12MM (Ref # 92015)	92015-1433	3
BUSHING (Ref # 92028)	92028-1598	4
BEARING-NEEDLE,18BM2416 (Ref # 92046)	92046-1144	2
BEARING-NEEDLE,16BM2212 (Ref # 92046A)	92046-1192	2
SEAL-OIL (Ref # 92049)	92049-0069	2
SEAL-OIL (Ref # 92049A)	92049-0112	2
SEAL-OIL,ARM (Ref # 92049B)	92049-1109	2
SEAL-OIL (Ref # 92049C)	92049-1328	2
SEAL (Ref # 92093)	92093-0139	2
BOLT,FLANGED,10X45 (Ref # 92151)	92151-1413	1
COLLAR (Ref # 92152)	92152-1139	1
BOLT,12X95 (Ref # 92153)	92153-1827	1
BOLT,12X85 (Ref # 92153A)	92153-1828	1
BOLT,12X108 (Ref # 92153B)	92153-1829	1
BOLT,FLANGED,10X42 (Ref # 92153C)	92153-1957	1