

2019 Z125 PRO PARTS DIAGRAM

Swingarm/Shock Absorber

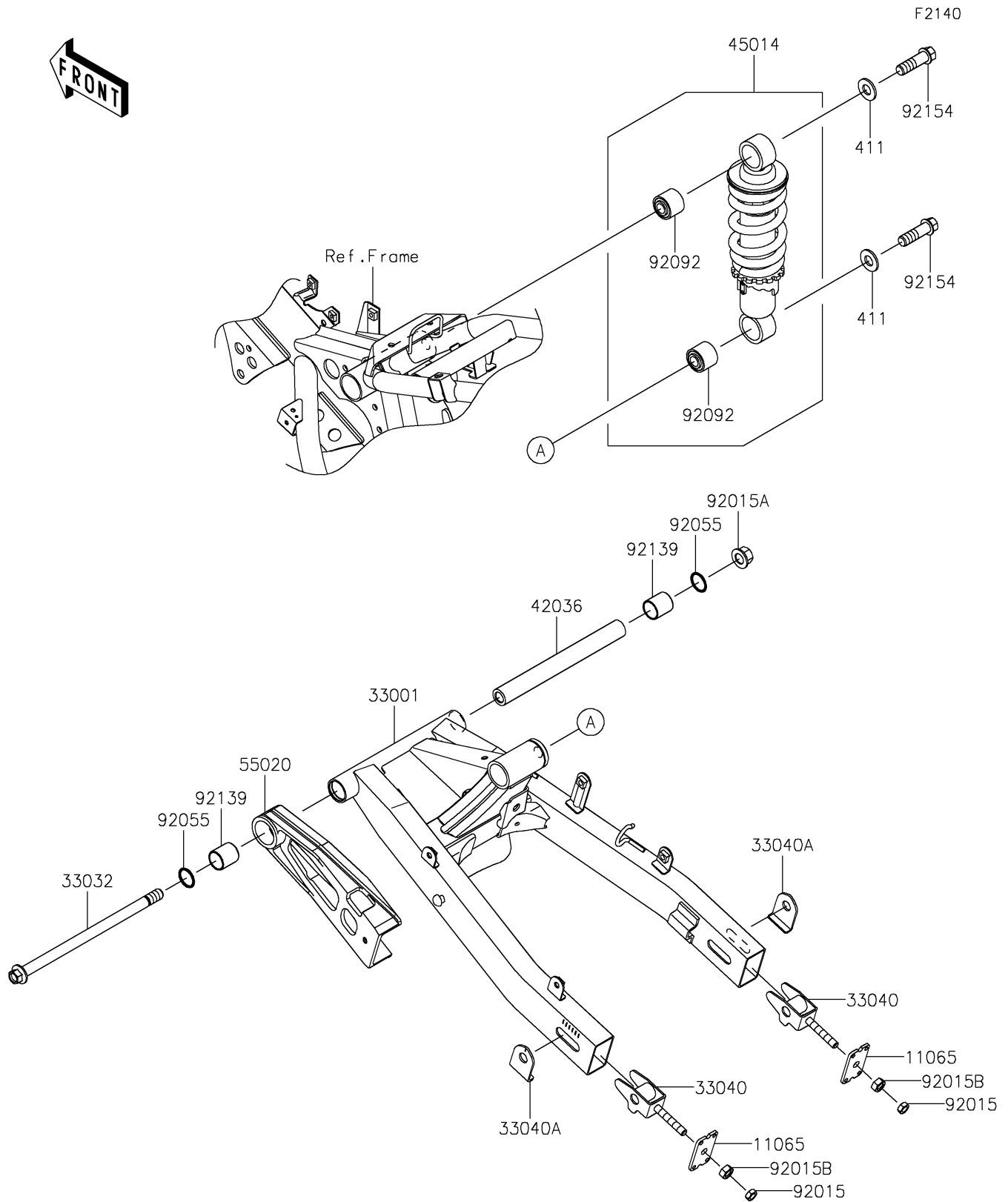

2019 Z125 PRO PARTS LIST

Swingarm/Shock Absorber

ITEM NAME	PART NUMBER	QUANTITY
CAP (Ref # 11065)	11065-0916	2
ARM-COMP-SWING,F.S.BLACK (Ref # 33001)	33001-0647-18R	1
SHAFT-SWING ARM (Ref # 33032)	33032-0047	1
ADJUSTER-CHAIN (Ref # 33040)	33040-0082	2
ADJUSTER-CHAIN (Ref # 33040A)	33040-0083	2
WASHER-PLAIN,12MM (Ref # 411)	411AA1200	2
SLEEVE,12.1X20X189.5 (Ref # 42036)	42036-0774	1
SHOCKABSORBER,P.SILVER (Ref # 45014)	45014-0512-458	1
GUARD (Ref # 55020)	55020-1902	1
NUT,8MM (Ref # 92015)	92015-1364	2
NUT,12MM (Ref # 92015A)	92015-1426	1
NUT,8MM (Ref # 92015B)	92015-1658	2
RING-O,19.8X2.2 (Ref # 92055)	92055-1215	2
BUSHING-RUBBER (Ref # 92092)	92092-0033	2
BUSHING,20X23X25 (Ref # 92139)	92139-0778	2
BOLT,FLANGED,12X40 (Ref # 92154)	92154-1789	2