

2007 Brute Force 650 4x4 Hardwoods Green HD PARTS DIAGRAM

Crankcase

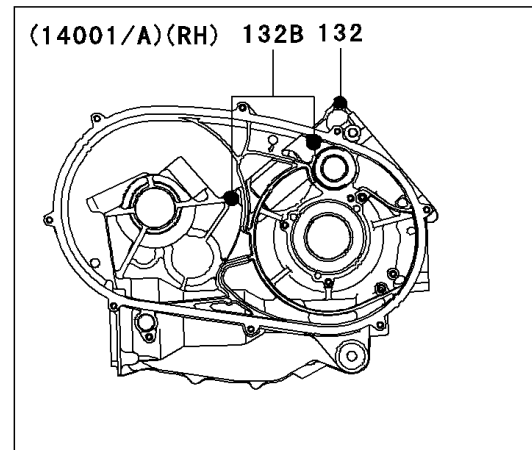
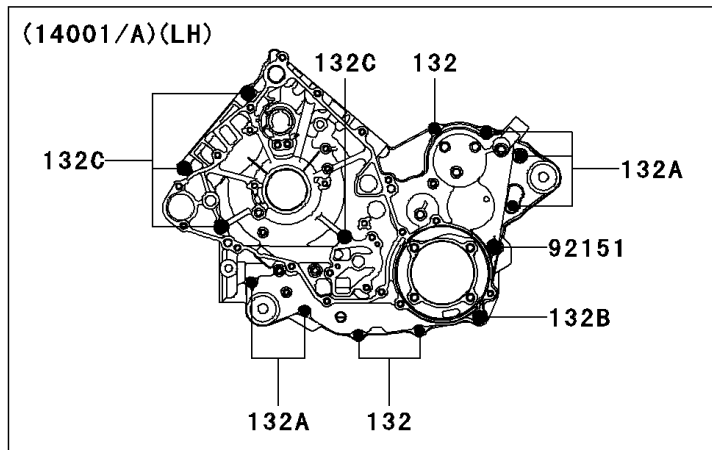
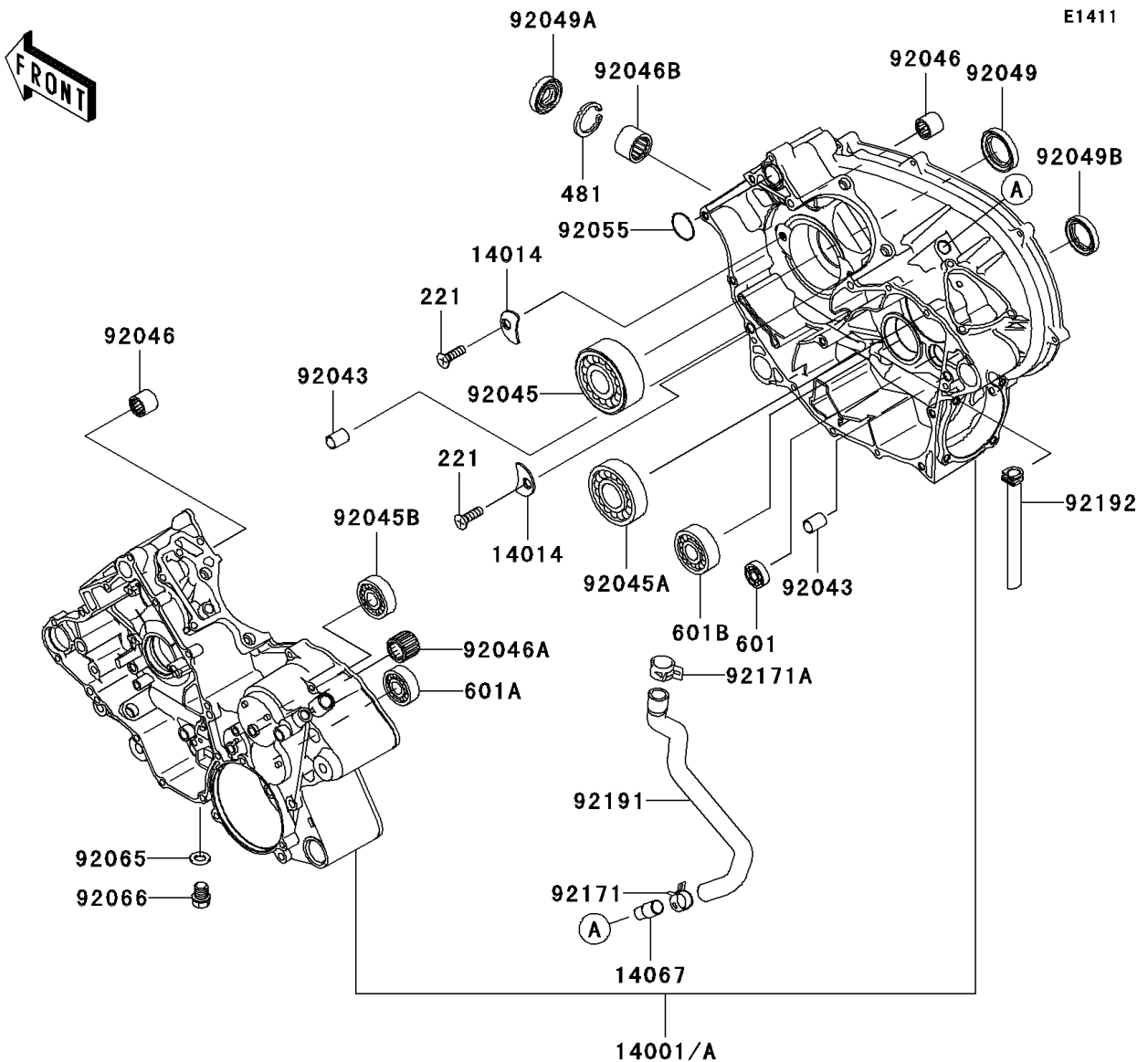

2007 Brute Force 650 4x4 Hardwoods Green HD PARTS LIST

Crankcase

ITEM NAME	PART NUMBER	QUANTITY
BOLT-FLANGED-SMALL,6X40 (Ref # 132)	132BD0640	4
BOLT-FLANGED-SMALL,6X65 (Ref # 132A)	132BD0665	5
BOLT-FLANGED-SMALL,8X110 (Ref # 132B)	132BD08110	3
BOLT-FLANGED-SMALL,8X75 (Ref # 132C)	132BD0875	4
SCREW-CSK-CROS,6X16 (Ref # 221)	221AA0616	2
CIRCLIP-TYPE-C,37MM (Ref # 481)	481J3700	1
BEARING-BALL (Ref # 601)	601A6000	1
BEARING-BALL,#6004 (Ref # 601A)	601A6004	1
BEARING-BALL,#6304 (Ref # 601B)	601A6304	1
SET-CRANKCASE (Ref # 14001)	14001-0044	1
PLATE-POSITION (Ref # 14014)	14014-0006	2
FITTING,BREATHER (Ref # 14067)	14067-006	1
PIN,10X14 (Ref # 92043)	92043-1506	2
BEARING-BALL,5208X2-A-ECG45 (Ref # 92045)	92045-0012	1
BEARING-BALL,6306SH2 (Ref # 92045A)	92045-1190	1
BEARING-BALL,6303LUA (Ref # 92045B)	92045-1389	1
BEARING-NEEDLE,TA202715ZE (Ref # 92046)	92046-1118	2
BEARING-NEEDLE (Ref # 92046A)	92046-1143	1
BEARING-NEEDLE,FJ-2820WA (Ref # 92046B)	92046-1277	1
SEAL-OIL,TC 35X50X8 (Ref # 92049)	92049-1452	1
SEAL-OIL,TCY 28X42X8 (Ref # 92049A)	92049-1570	1
SEAL-OIL,HTC 30X45X8 (Ref # 92049B)	92049-1575	1
RING-O,25.7X2.4 (Ref # 92055)	92055-1136	1
GASKET,12X22X2 (Ref # 92065)	92065-097	1
PLUG,OIL DRAIN,12X15 (Ref # 92066)	92066-1174	1
BOLT,8X110 (Ref # 92151)	92151-1689	1
CLAMP (Ref # 92171)	92171-0329	1
CLAMP (Ref # 92171A)	92171-0514	1
TUBE,BREATHER (Ref # 92191)	92191-1740	1

2007 Brute Force 650 4x4 Hardwoods Green HD PARTS LIST

Crankcase

ITEM NAME	PART NUMBER	QUANTITY
TUBE,OIL RETURN (Ref # 92192)	92192-0057	1