

# 2009 Brute Force 650 4x4 Hardwoods Green HD PARTS DIAGRAM

## Frame Fittings

F2131

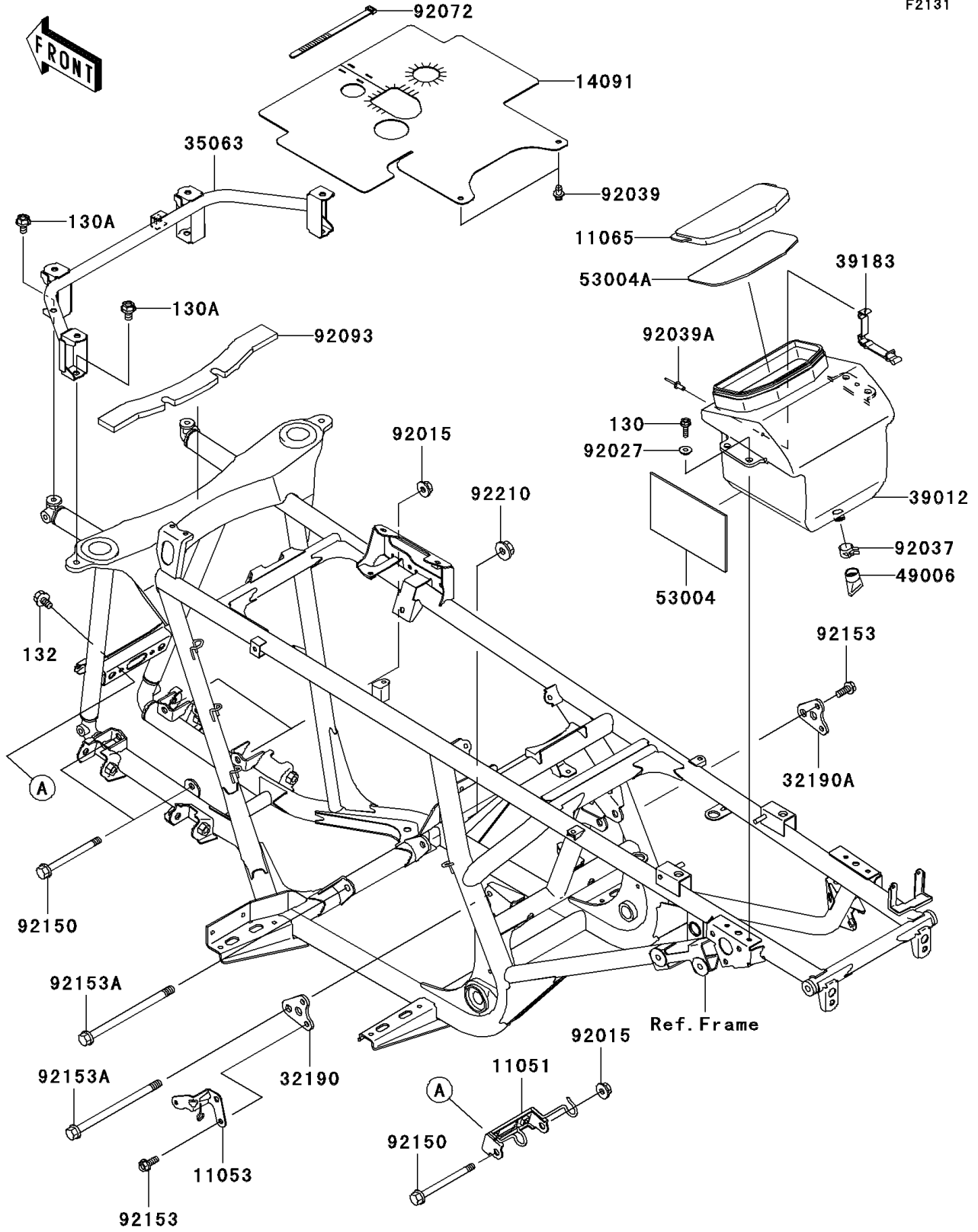

## 2009 Brute Force 650 4x4 Hardwoods Green HD PARTS LIST

### Frame Fittings

ITEM NAME	PART NUMBER	QUANTITY
BOLT-FLANGED,6X20 (Ref # 130)	130BA0620	4
BOLT-FLANGED,8X14 (Ref # 130A)	130CB0814	4
BOLT-FLANGED-SMALL,8X14 (Ref # 132)	132BB0814	2
BRACKET,FRONT DIFF (Ref # 11051)	11051-1929	1
BRACKET,RESERVOIR TANK (Ref # 11053)	11053-0481	1
CAP,STORAGE CASE (Ref # 11065)	11065-1154	1
COVER,FR,UPP (Ref # 14091)	14091-0416	1
BRACKET-ENGINE,RR,UPP,LH (Ref # 32190)	32190-0045	1
BRACKET-ENGINE,RR,UPP,RH (Ref # 32190A)	32190-0046	1
STAY,CARRIER (Ref # 35063)	35063-0201	1
CASE-STORAGE (Ref # 39012)	39012-1064	1
BAND-ASSY,TOOL BAG (Ref # 39183)	39183-1065	1
BOOT (Ref # 49006)	49006-1292	1
MAT,STORAGE CASE (Ref # 53004)	53004-1139	1
MAT,STORAGE CASE CAP (Ref # 53004A)	53004-1147	1
NUT,LOCK,FLANGED,10MM (Ref # 92015)	92015-1717	3
COLLAR (Ref # 92027)	92027-1936	4
CLAMP,HOSE CLIP (Ref # 92037)	92037-1460	1
RIVET (Ref # 92039)	92039-1229	2
RIVET,4.8MM (Ref # 92039A)	92039-3719	2
BAND,L=123 (Ref # 92072)	92072-030	2
SEAL (Ref # 92093)	92093-1555	1
BOLT,FLANGED,10X120 (Ref # 92150)	92150-1642	3
BOLT,FLANGED,8X20 (Ref # 92153)	92153-0948	4
BOLT,FLANGED,12X190 (Ref # 92153A)	92153-1272	2
NUT,LOCK,FLANGED,12MM (Ref # 92210)	92210-1150	1