

2009 Brute Force 650 4x4i Hardwoods Green HD PARTS DIAGRAM

Chassis Electrical Equipment

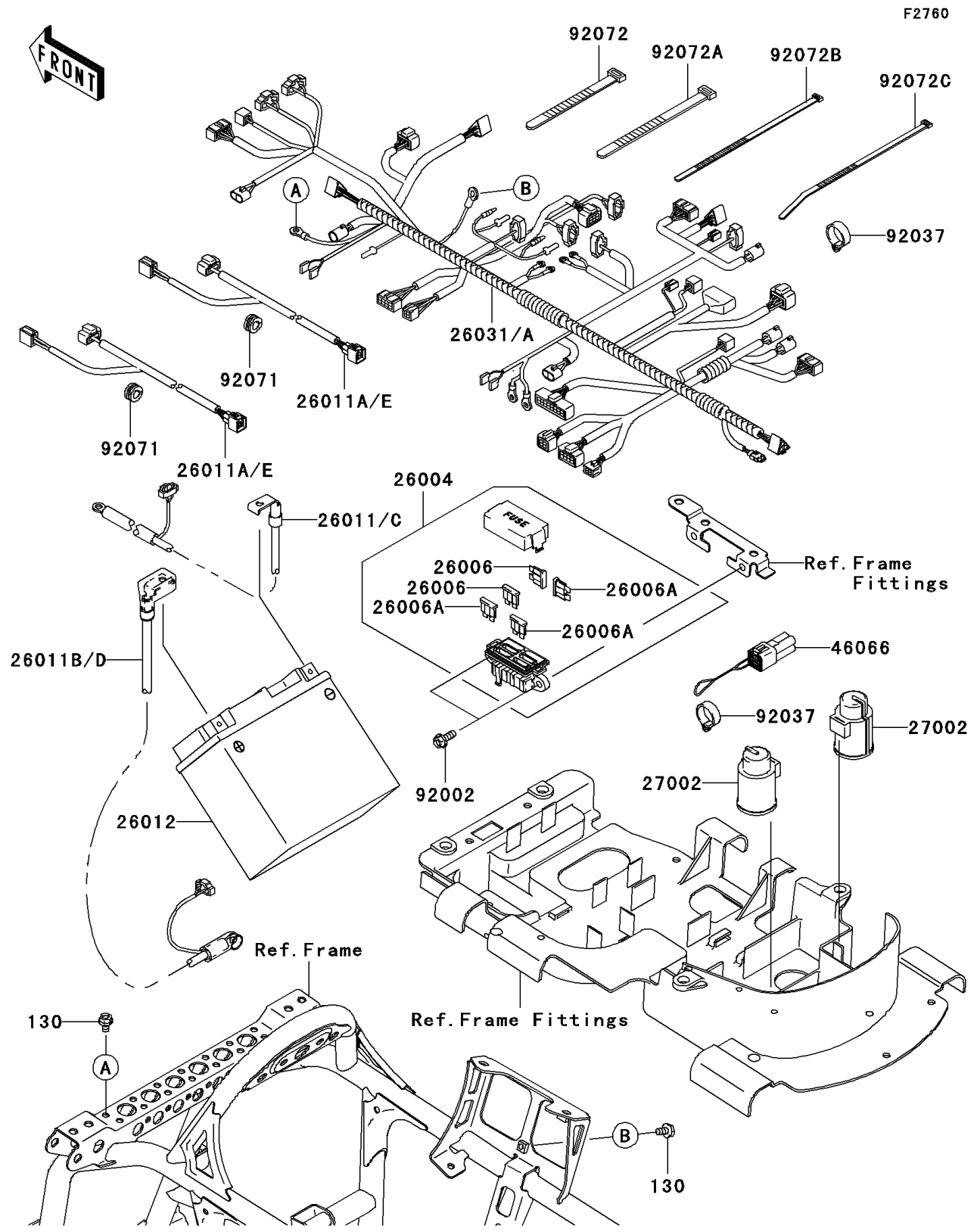

2009 Brute Force 650 4x4i Hardwoods Green HD PARTS LIST

Chassis Electrical Equipment

ITEM NAME	PART NUMBER	QUANTITY
BOLT-FLANGED,6X10 (Ref # 130)	130BB0610	2
FUSE-ASSY (Ref # 26004)	26004-0011	1
FUSE,30A (Ref # 26006)	26006-0004	2
FUSE,10A (Ref # 26006A)	26006-0005	3
WIRE-LEAD,BATTERY(-) (Ref # 26011C)	26011-0137	1
WIRE-LEAD,BATTERY(+) (Ref # 26011D)	26011-0138	1
WIRE-LEAD,HEAD LAMP (Ref # 26011E)	26011-0141	2
BATTERY,MF,KMX14-BS,12V 12AH (Ref # 26012)	26012-1414	1
HARNESS,MAIN (Ref # 26031A)	26031-0441	1
RELAY-ASSY (Ref # 27002)	27002-1095	2
CONNECTOR-ASSY,RESET (Ref # 46066)	46066-0001	1
BOLT,6X16 (Ref # 92002)	92002-1571	2
CLAMP,HOSE (Ref # 92037)	92037-1827	10
GROMMET (Ref # 92071)	92071-1128	2
BAND,L=123 (Ref # 92072)	92072-030	3
BAND,L=149 (Ref # 92072A)	92072-031	1
BAND,L=188 (Ref # 92072B)	92072-1239	4
BAND,L=292.1 (Ref # 92072C)	92072-3509	1