

# 2019 VULCAN® S PARTS DIAGRAM

Tires

F2210

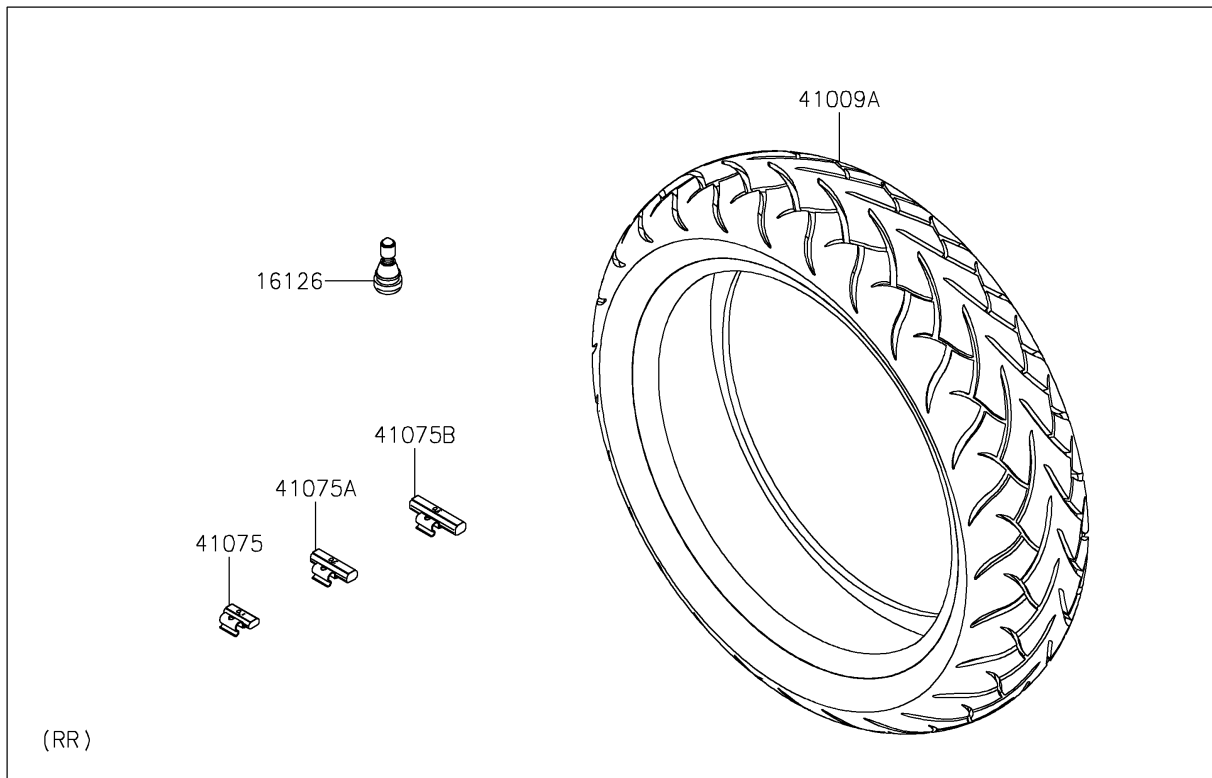
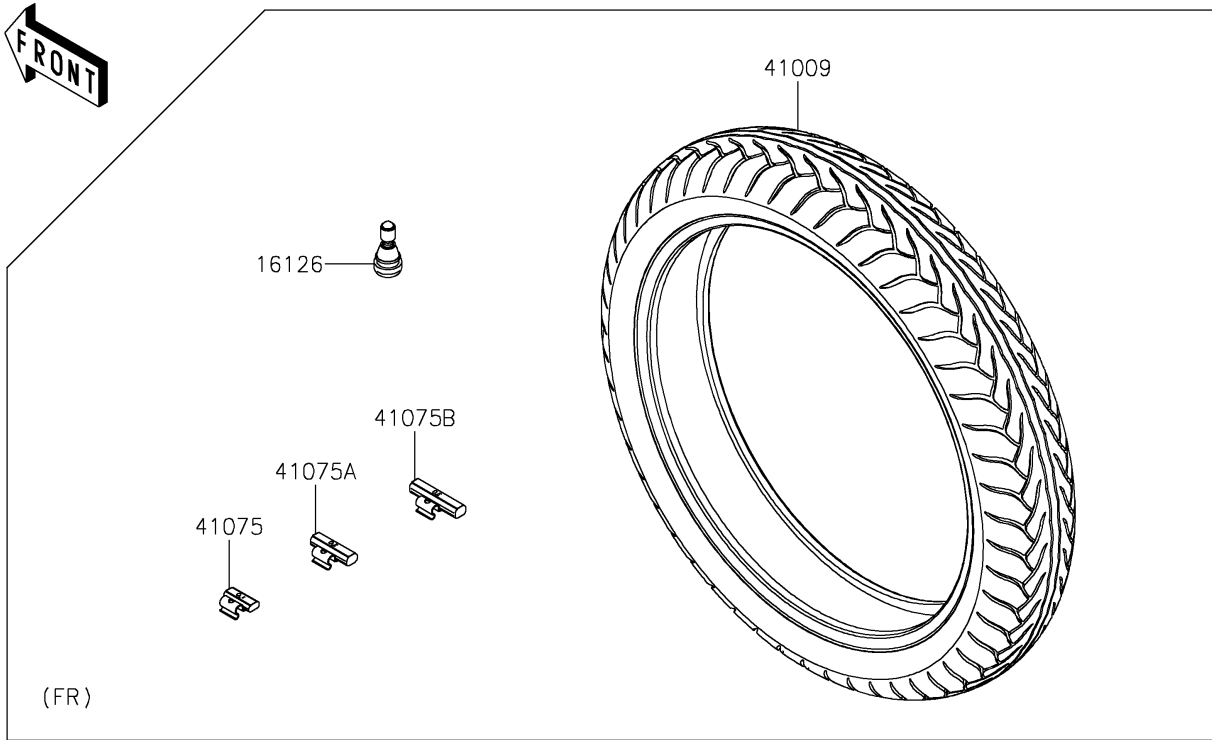

## 2019 VULCAN® S PARTS LIST

### Tires

| ITEM NAME                                     | PART NUMBER | QUANTITY |
|---|-------------|----------|
| VALVE,TIRE (Ref # 16126)                      | 16126-1140  | 2        |
| TIRE,FR,120/70R18(59H),D220F (Ref # 41009)    | 41009-0659  | 1        |
| TIRE,RR,160/60ZR17(69H),D220ST (Ref # 41009A) | 41009-0693  | 1        |
| BALANCER-WHEEL,10G,SILVER (Ref # 41075)       | 41075-0007  | AR       |
| BALANCER-WHEEL,20G,SILVER (Ref # 41075A)      | 41075-0008  | AR       |
| BALANCER-WHEEL,30G,SILVER (Ref # 41075B)      | 41075-0009  | AR       |