

2020 VERSYS®-X 300 PARTS DIAGRAM

Engine Cover(s)

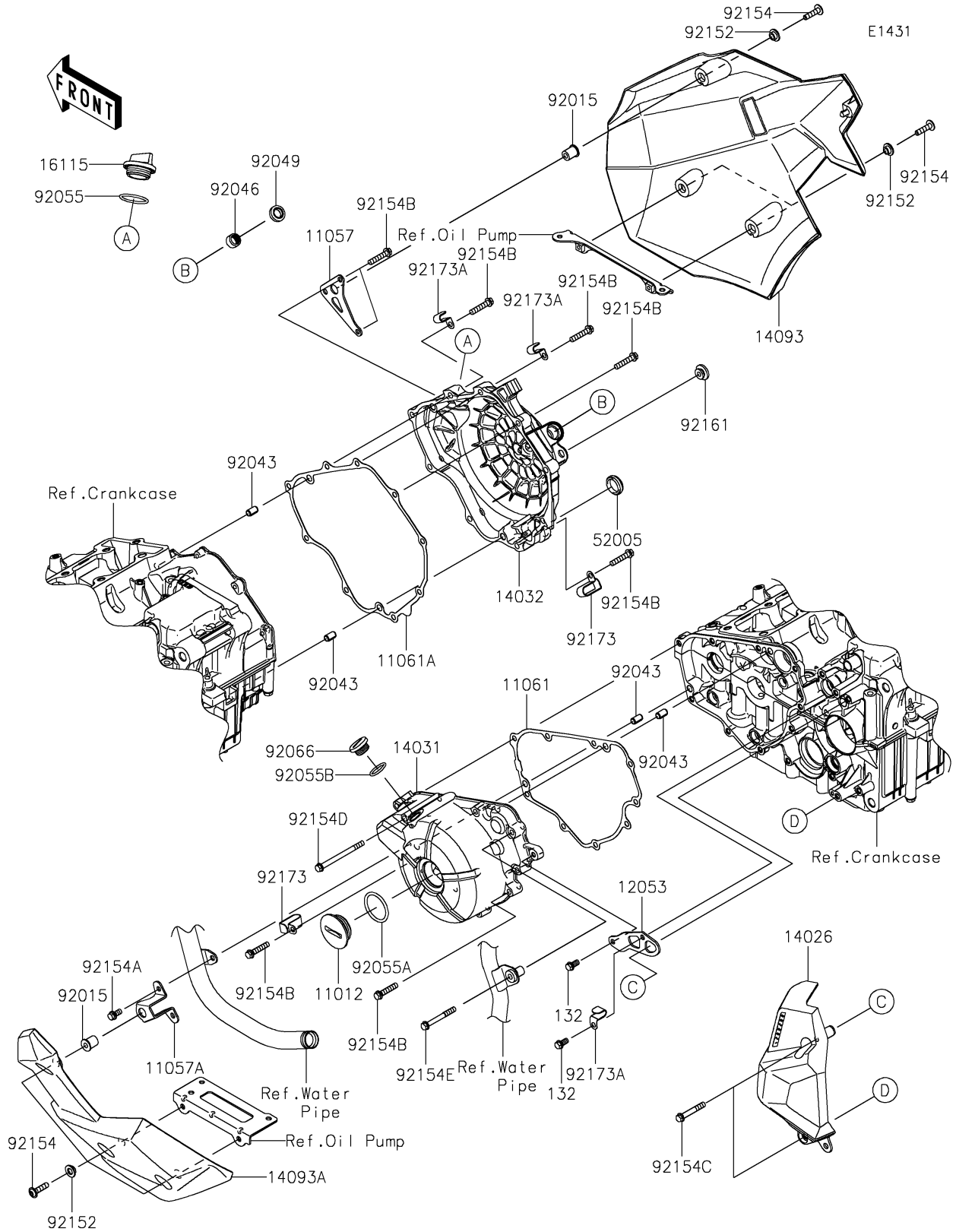

2020 VERSYS®-X 300 PARTS LIST

Engine Cover(s)

ITEM NAME	PART NUMBER	QUANTITY
CAP (Ref # 11012)	11012-1362	1
BRACKET,RIGHT LOWER COVER (Ref # 11057)	11057-0623	1
BRACKET,LEFT LOWER COVER (Ref # 11057A)	11057-0674	1
GASKET,GENERATOR COVER (Ref # 11061)	11061-0793	1
GASKET,CLUTCH COVER (Ref # 11061A)	11061-0854	1
GUIDE-CHAIN (Ref # 12053)	12053-0237	1
BOLT-FLANGED-SMALL,6X12 (Ref # 132)	132BA0612	2
COVER-CHAIN (Ref # 14026)	14026-0133	1
COVER-GENERATOR (Ref # 14031)	14031-0562	1
COVER-CLUTCH (Ref # 14032)	14032-0633	1
COVER,LWR,RH (Ref # 14093)	14093-0548	1
COVER,LWR,LH (Ref # 14093A)	14093-0549	1
CAP-OIL FILLER (Ref # 16115)	16115-1068	1
GAUGE,OIL LEVEL (Ref # 52005)	52005-1009	1
NUT (Ref # 92015)	92015-1700	2
PIN,6.2X8X14 (Ref # 92043)	92043-1263	4
BEARING-NEEDLE,HK1210FM (Ref # 92046)	92046-0034	1
SEAL-OIL (Ref # 92049)	92049-1560	1
RING-O,31.5X2.6 (Ref # 92055)	92055-049	1
RING-O,39.4X3.1 (Ref # 92055A)	92055-0734	1
RING-O,20X2 (Ref # 92055B)	92055-1146	1
PLUG (Ref # 92066)	92066-0748	1
COLLAR (Ref # 92152)	92152-2296	6
BOLT,SOCKET,6X25 (Ref # 92154)	92154-0071	6
BOLT,FLANGED,6X12 (Ref # 92154A)	92154-1140	2
BOLT,FLANGED,6X30 (Ref # 92154B)	92154-1773	16
BOLT,FLANGED,6X40 (Ref # 92154C)	92154-1774	2
BOLT,FLANGED,6X75 (Ref # 92154D)	92154-2346	1
BOLT,FLANGED,6X50 (Ref # 92154E)	92154-2347	1

2020 VERSYS®-X 300 PARTS LIST

Engine Cover(s)

ITEM NAME	PART NUMBER	QUANTITY
DAMPER (Ref # 92161)	92161-1810	1
CLAMP (Ref # 92173)	92173-0833	2
CLAMP (Ref # 92173A)	92173-1811	3