

2007 Vulcan 500 LTD PARTS DIAGRAM

Front Brake

F2292

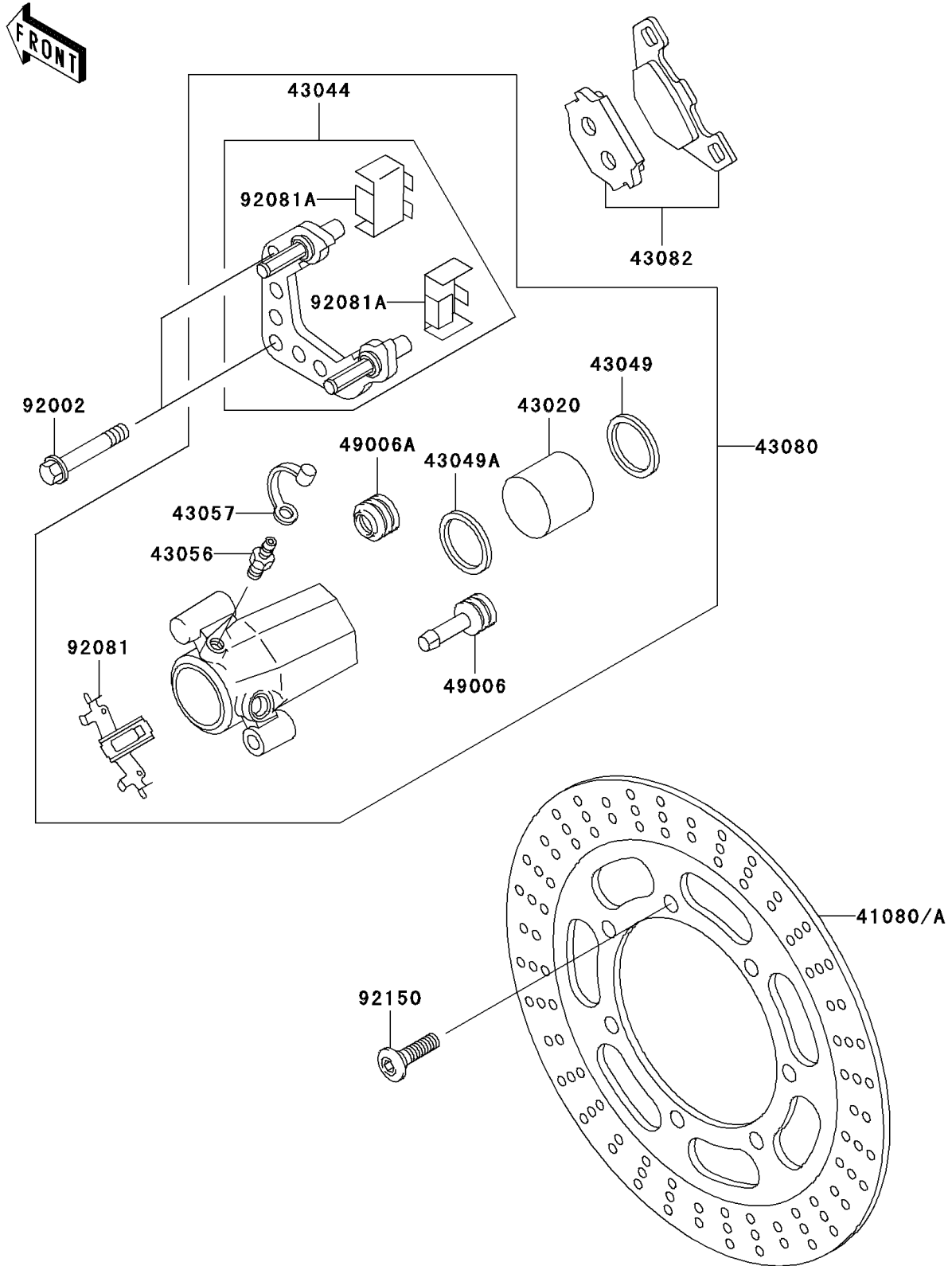

2007 Vulcan 500 LTD PARTS LIST

Front Brake

ITEM NAME	PART NUMBER	QUANTITY
DISC,FR,SILVER (Ref # 41080)	41080-0009-CM	1
PISTON-COMP-BRAKE (Ref # 43020)	43020-1066	1
HOLDER-COMP-CALIPER,FR,LH (Ref # 43044)	43044-1102	1
PACKING,PISTON (Ref # 43049)	43049-1028	1
PACKING,PISTON SEAL (Ref # 43049A)	43049-1098	1
BREATHER-BRAKE (Ref # 43056)	43056-1054	1
CAP-BREATHER (Ref # 43057)	43057-003	1
CALIPER-SUB-ASSY,FR,LH,SILVER (Ref # 43080)	43080-5005-GN	1
PAD-ASSY-BRAKE (Ref # 43082)	43082-1080	1
BOOT,CALIPER (Ref # 49006)	49006-1094	1
BOOT,CALIPER (Ref # 49006A)	49006-1095	1
BOLT,FLANGED,10X47 (Ref # 92002)	92002-1469	2
SPRING,PAD (Ref # 92081)	92081-1525	1
SPRING,PAD STOPPER (Ref # 92081A)	92081-1661	2
BOLT,SOCKET,8X30 (Ref # 92150)	92150-1771	7