

# 2020 NINJA® ZX™ -10R ABS KRT EDITION PARTS DIAGRAM

Crankshaft/Piston(s)

E1320

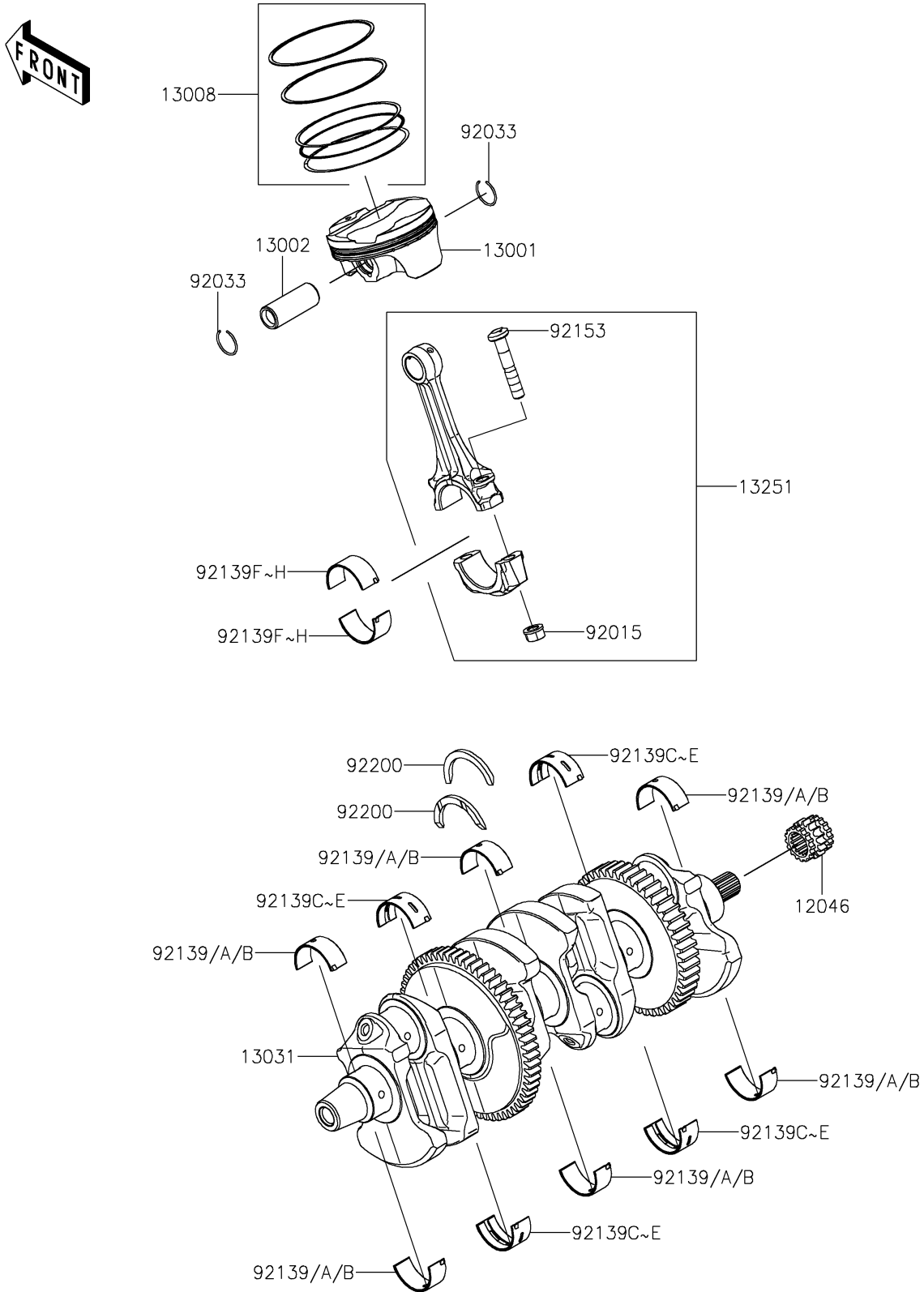

## 2020 NINJA® ZX™ -10R ABS KRT EDITION PARTS LIST

### Crankshaft/Piston(s)

ITEM NAME	PART NUMBER	QUANTITY
SPROCKET,15T (Ref # 12046)	12046-0611	1
PISTON-ENGINE (Ref # 13001)	13001-0800	4
PIN-PISTON (Ref # 13002)	13002-0717	4
RING-SET-PISTON (Ref # 13008)	13008-0562	4
CRANKSHAFT-COMP (Ref # 13031)	13031-0881	1
ROD-ASSY-CONNECTING,H (Ref # 13251)	13251-0725-HH	4
NUT,FLANGED,8MM (Ref # 92015)	92015-1311	8
RING-SNAP (Ref # 92033)	92033-1054	8
BUSHING,#1&#3&#5,BLUE (Ref # 92139)	92139-0298	AR
BUSHING,#1&#3&#5,BLACK (Ref # 92139A)	92139-0299	6
BUSHING,#1&#3&#5,BROWN (Ref # 92139B)	92139-0300	AR
BUSHING,#2&#4,BLUE (Ref # 92139C)	92139-0301	AR
BUSHING,#2&#4,BLACK (Ref # 92139D)	92139-0302	4
BUSHING,#2&#4,BROWN (Ref # 92139E)	92139-0303	AR
BUSHING,PIN,BLUE (Ref # 92139F)	92139-0853	8
BUSHING,PIN,BLACK (Ref # 92139G)	92139-0854	AR
BUSHING,PIN,BROWN (Ref # 92139H)	92139-0855	AR
BOLT,CON-ROD,8X45.5 (Ref # 92153)	92153-0809	8
WASHER,T=3.25 (Ref # 92200)	92200-0424	2