

2020 NINJA® ZX™ -10R ABS KRT EDITION PARTS DIAGRAM

Cables

F2540

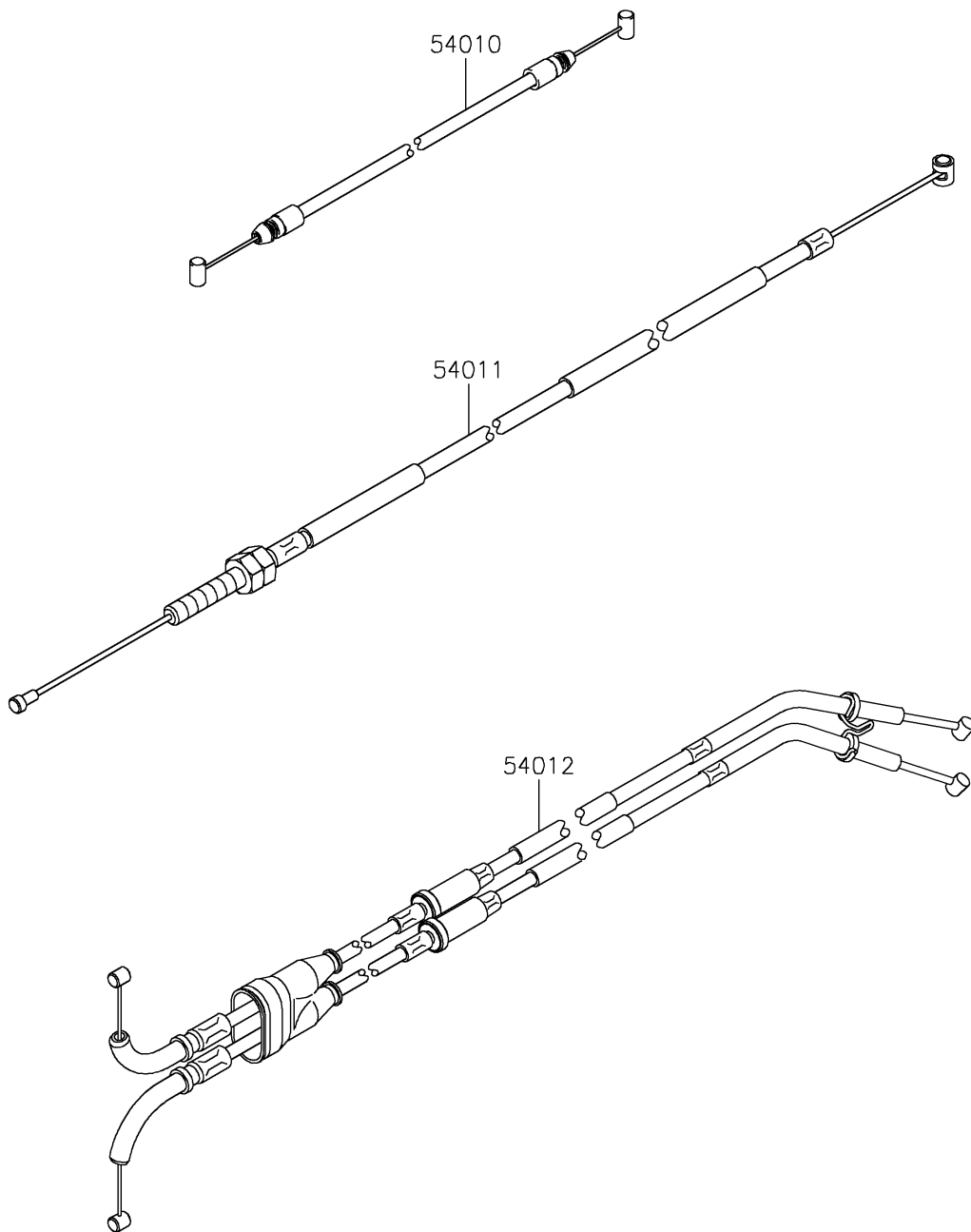

2020 NINJA® ZX™ -10R ABS KRT EDITION PARTS LIST

Cables

ITEM NAME	PART NUMBER	QUANTITY
CABLE,SEAT LOCK (Ref # 54010)	54010-0609	1
CABLE-CLUTCH (Ref # 54011)	54011-0612	1
CABLE-THROTTLE (Ref # 54012)	54012-0631	1