

1999 KX100 PARTS DIAGRAM

Cylinder Head/Cylinder

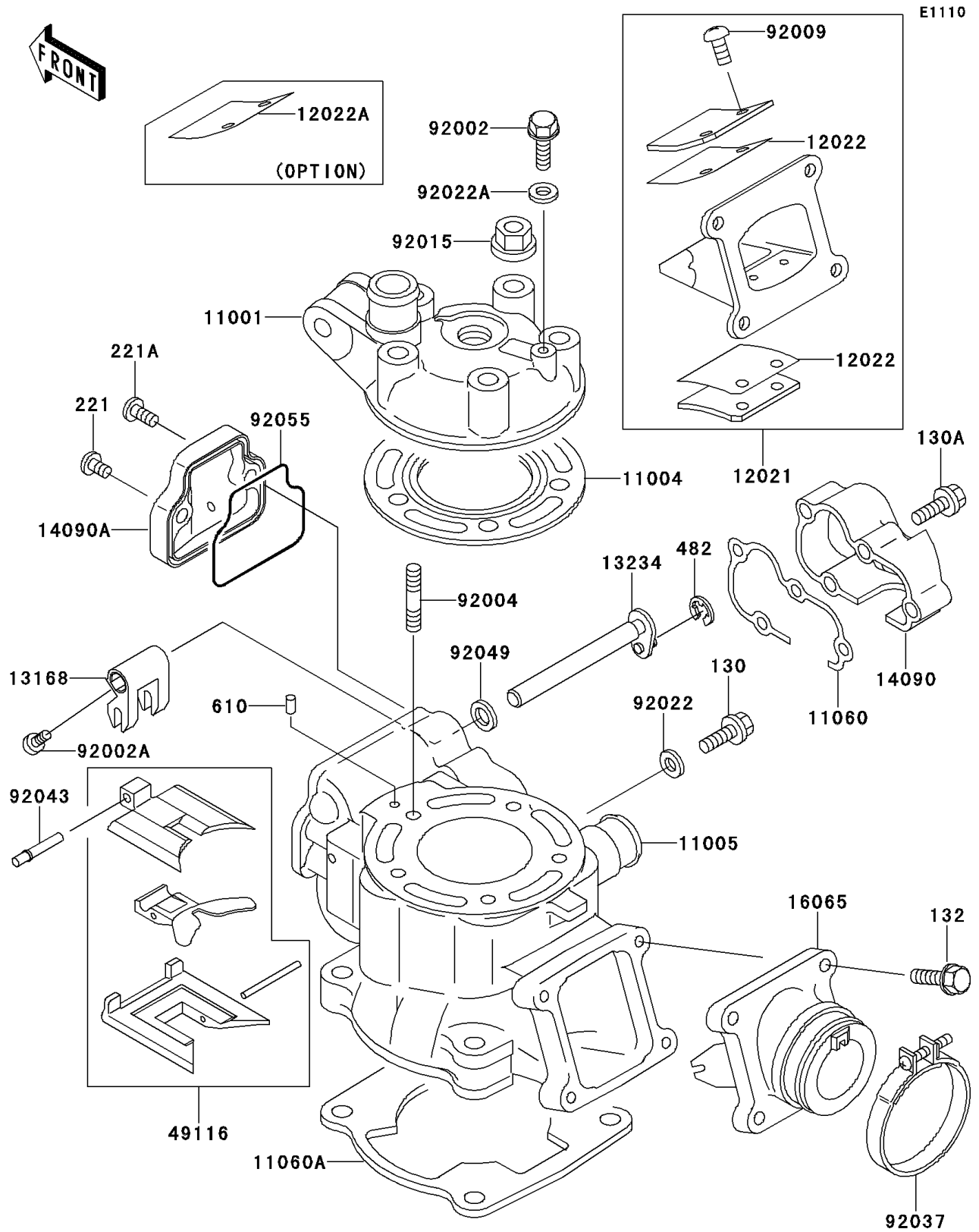

1999 KX100 PARTS LIST

Cylinder Head/Cylinder

ITEM NAME	PART NUMBER	QUANTITY
BOLT-FLANGED,6X8 (Ref # 130)	130B0608	1
BOLT-FLANGED (Ref # 130A)	130G0525	4
BOLT-FLANGED-SMALL (Ref # 132)	132G0620	4
SCREW-CSK-CROS,6X16 (Ref # 221)	221B0616	1
SCREW-CSK-CROS,6X20 (Ref # 221A)	221B0620	1
CIRCLIP-TYPE-E (Ref # 482)	482J5000	1
ROLLER,4X8 (Ref # 610)	610A0408	1
HEAD-CYLINDER (Ref # 11001)	11001-1463	1
GASKET-HEAD (Ref # 11004)	11004-1214	1
CYLINDER-ENGINE (Ref # 11005)	11005-1846	1
GASKET,GOVERNOR COVER (Ref # 11060)	11060-1778	1
GASKET,CYLINDER BASE (Ref # 11060A)	11060-1779	1
VALVE-ASSY-REED (Ref # 12021)	12021-1114	1
VALVE-REED,T=0.42 (Ref # 12022)	12022-1054	2
VALVE-REED,T=0.37,CARBON (Ref # 12022A)	12022-1086	2
LEVER,MAIN VALVE (Ref # 13168)	13168-1499	1
SHAFT-COMP (Ref # 13234)	13234-1105	1
COVER (Ref # 14090)	14090-1811	1
COVER (Ref # 14090A)	14090-1812	1
HOLDER-CARBURETOR (Ref # 16065)	16065-1224	1
VALVE-ASSY (Ref # 49116)	49116-1158	1
BOLT,6X10 (Ref # 92002)	92002-1222	1
BOLT,SOCKET,4X8 (Ref # 92002A)	92002-1403	1
STUD,8X32 (Ref # 92004)	92004-1253	5
SCREW,REED VALVE (Ref # 92009)	92009-1014	4
NUT,8MM (Ref # 92015)	92015-1143	5
WASHER,6.1X12X1 (Ref # 92022)	92022-077	1
WASHER,6.2X11X1 (Ref # 92022A)	92022-304	1
CLAMP (Ref # 92037)	92037-1843	1

1999 KX100 PARTS LIST

Cylinder Head/Cylinder

ITEM NAME	PART NUMBER	QUANTITY
PIN,MAIN VALVE (Ref # 92043)	92043-1470	1
SEAL-OIL,SD088144 (Ref # 92049)	92049-1238	1
RING-O (Ref # 92055)	92055-1566	1