

# 2020 Ninja® 650 PARTS DIAGRAM

## Footrests

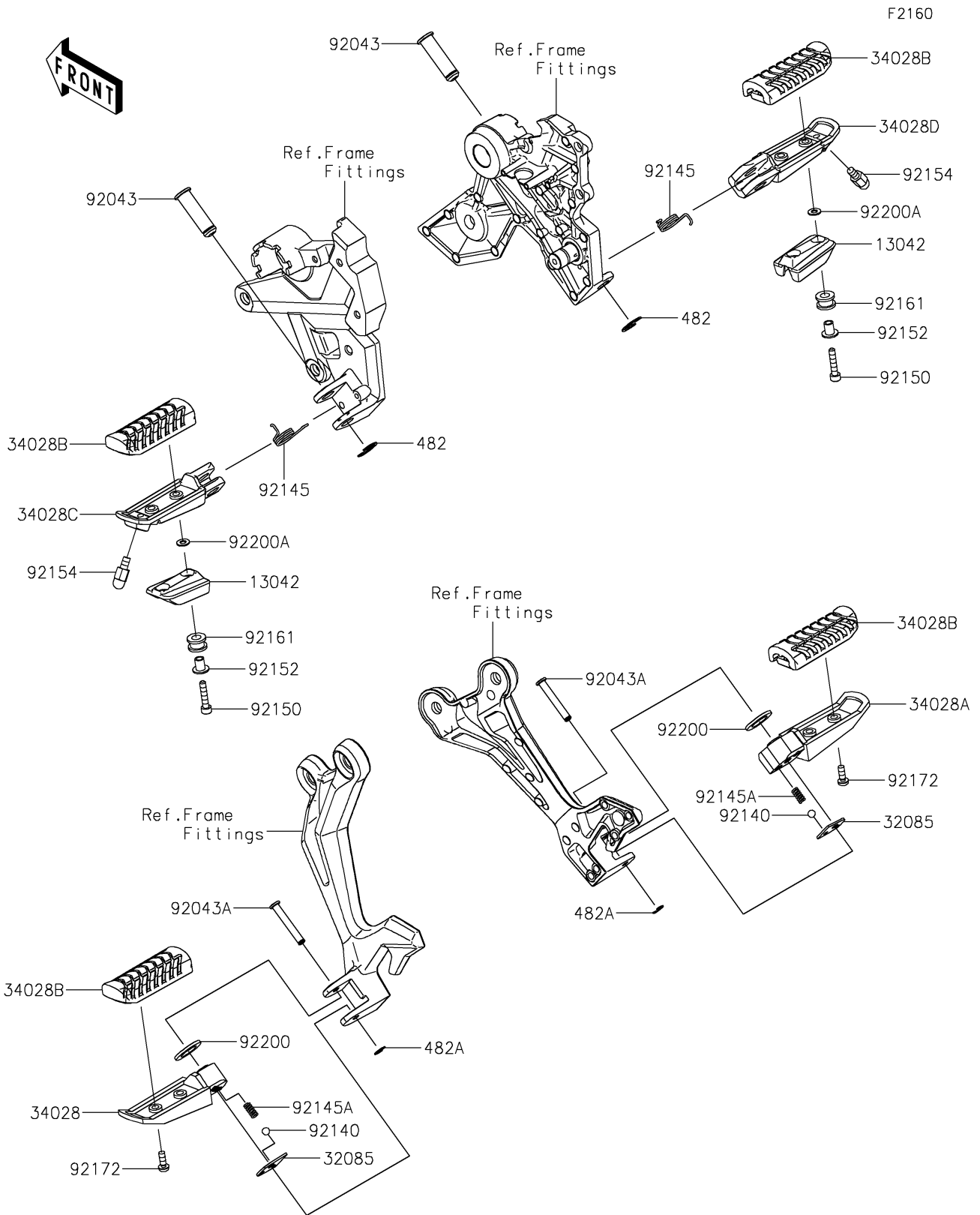

# 2020 Ninja® 650 PARTS LIST

Footrests

ITEM NAME	PART NUMBER	QUANTITY
-----------	-------------	----------