

2010 KLR™ 650 PARTS DIAGRAM

Gear Change Drum/Shift Fork(s)

E1362

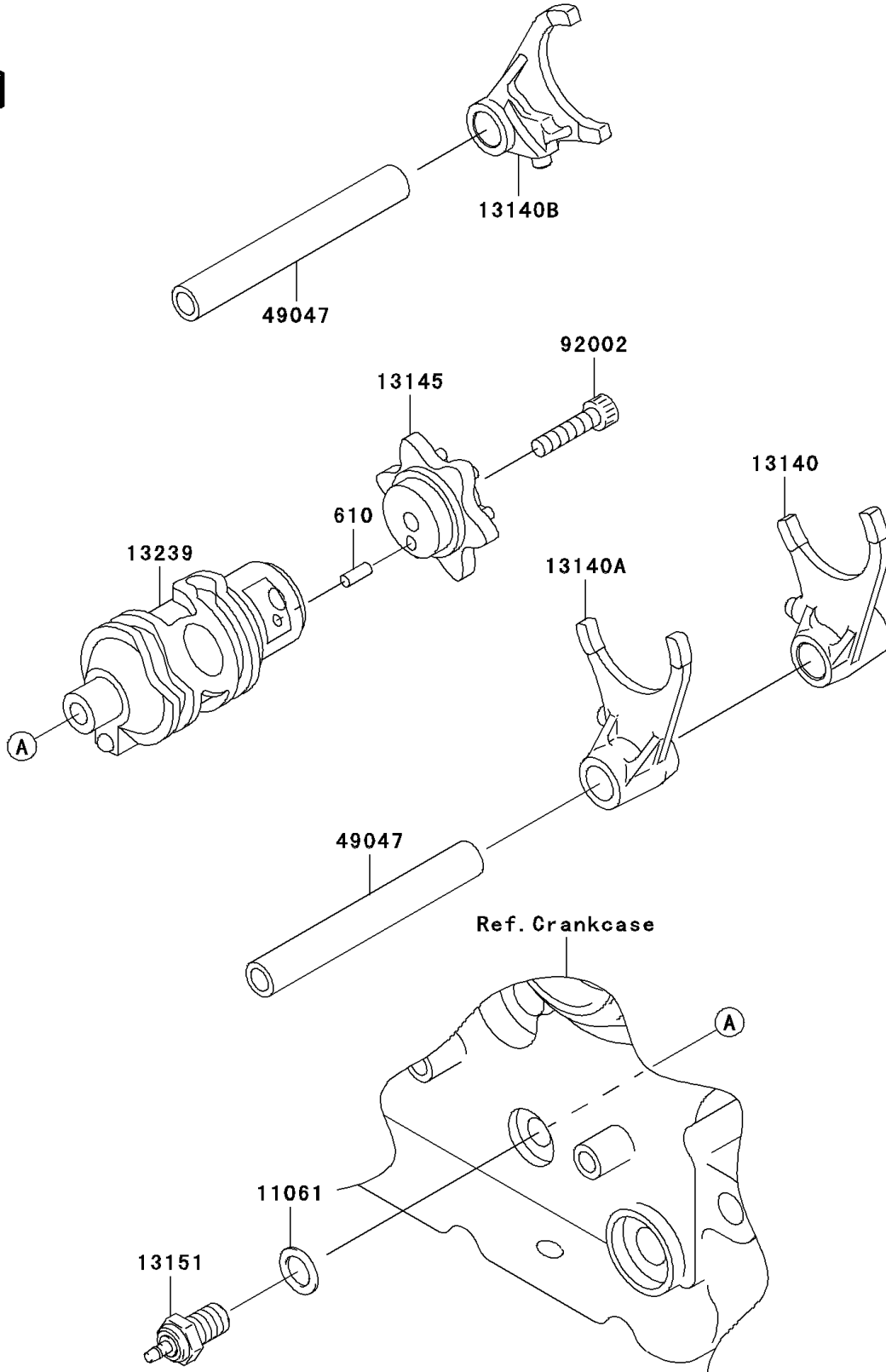

2010 KLR™ 650 PARTS LIST

Gear Change Drum/Shift Fork(s)

ITEM NAME	PART NUMBER	QUANTITY
ROLLER,4X10 (Ref # 610)	610A0410	1
GASKET,10.5X16X1 (Ref # 11061)	11061-0373	1
FORK-SHIFT,LOW (Ref # 13140)	13140-1023	1
FORK-SHIFT,2ND&3RD (Ref # 13140A)	13140-1024	1
FORK-SHIFT,4TH&TOP,36MM (Ref # 13140B)	13140-1288	1
CAM-CHANGE DRUM (Ref # 13145)	13145-0042	1
SWITCH-COMP,NEUTRAL (Ref # 13151)	13151-1080	1
DRUM-ASSY-CHANGE (Ref # 13239)	13239-1103	1
ROD-SHIFT,L=93.7 (Ref # 49047)	49047-1003	2
BOLT,SOCKET,6X25 (Ref # 92002)	92002-1696	1