

2000 KX125 PARTS DIAGRAM

Clutch

E1350

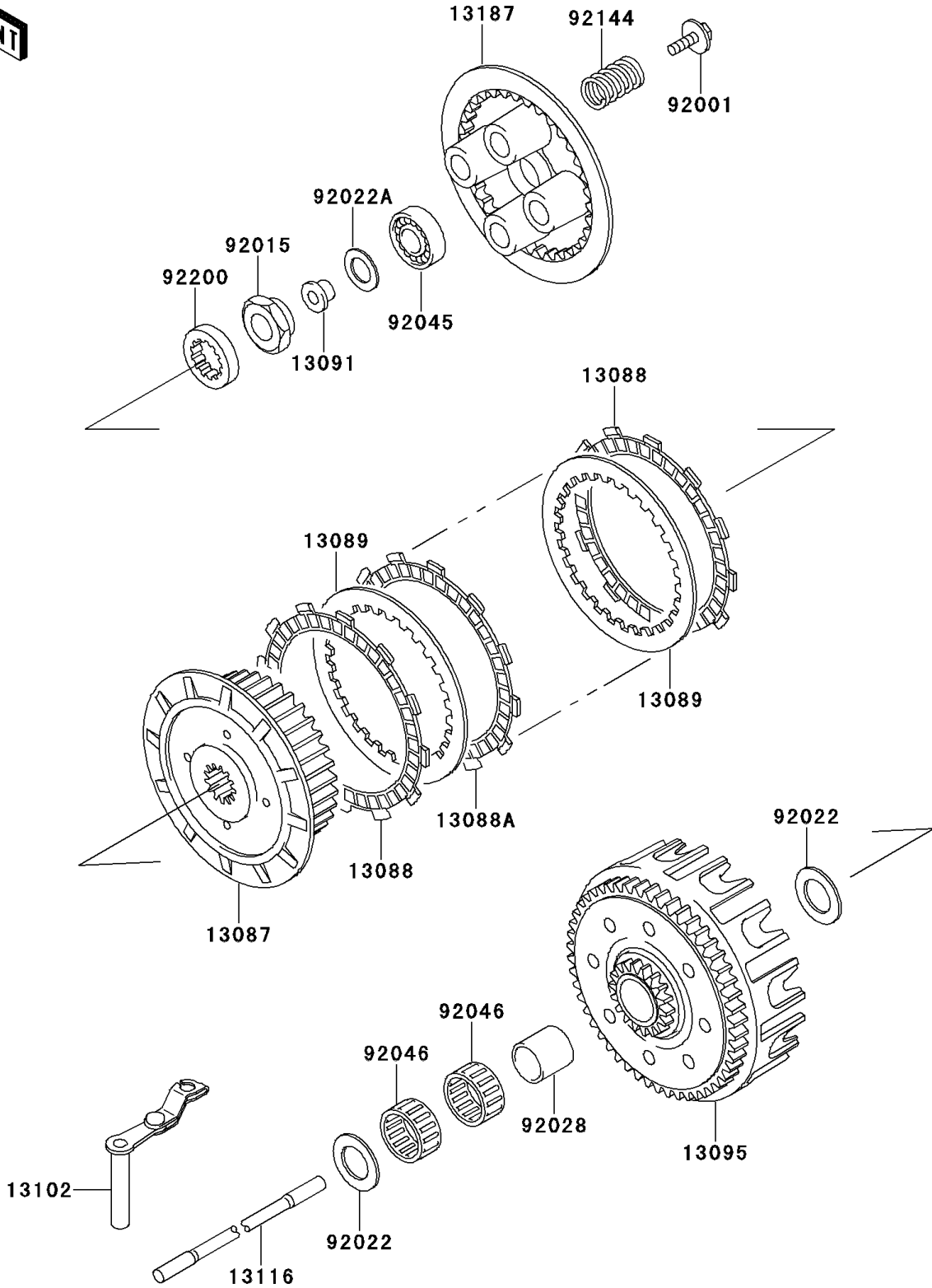

2000 KX125 PARTS LIST

Clutch

ITEM NAME	PART NUMBER	QUANTITY
HUB-CLUTCH (Ref # 13087)	13087-1167	1
PLATE-FRICTION (Ref # 13088)	13088-1057	2
PLATE-FRICTION (Ref # 13088A)	13088-1102	5
PLATE-CLUTCH,T=1.6 (Ref # 13089)	13089-013	6
HOLDER (Ref # 13091)	13091-1907	1
HOUSING-COMP-CLUTCH (Ref # 13095)	13095-1367	1
RELEASE-COMP-CLUTCH (Ref # 13102)	13102-1147	1
ROD-PUSH (Ref # 13116)	13116-1161	1
PLATE-CLUTCH OPERATING (Ref # 13187)	13187-1065	1
BOLT,FLANGED,6X18 (Ref # 92001)	92001-1066	4
NUT,M16 (Ref # 92015)	92015-1910	1
WASHER,20.5X34X1.4 (Ref # 92022)	92022-168	2
WASHER,12.3X20X0.5 (Ref # 92022A)	92022-269	1
BUSHING (Ref # 92028)	92028-1700	1
BEARING-BALL,6001C3ML01 (Ref # 92045)	92045-1235	1
BEARING-NEEDLE,K25X29X13 (Ref # 92046)	92046-1220	2
SPRING,CLUTCH (Ref # 92144)	92144-1993	4
WASHER (Ref # 92200)	92200-1178	1