

2001 KX125 PARTS DIAGRAM

Kickstarter Mechanism

E1340

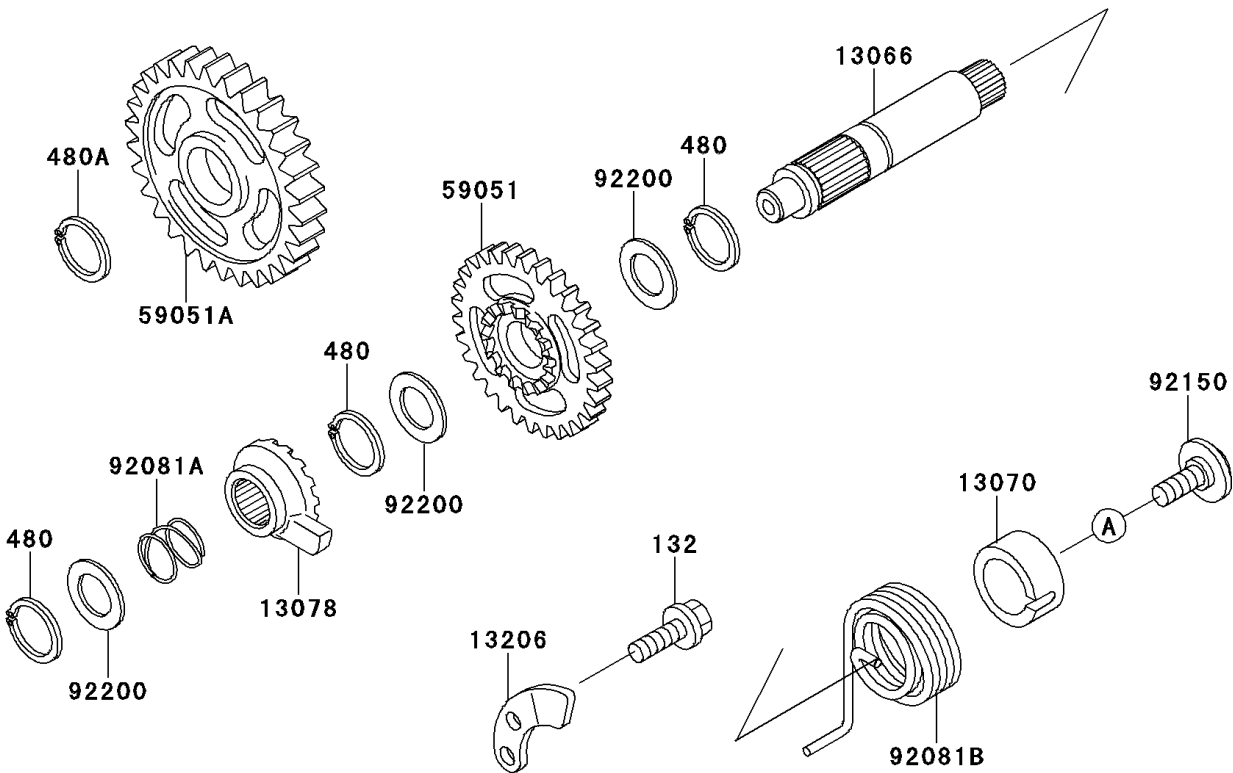
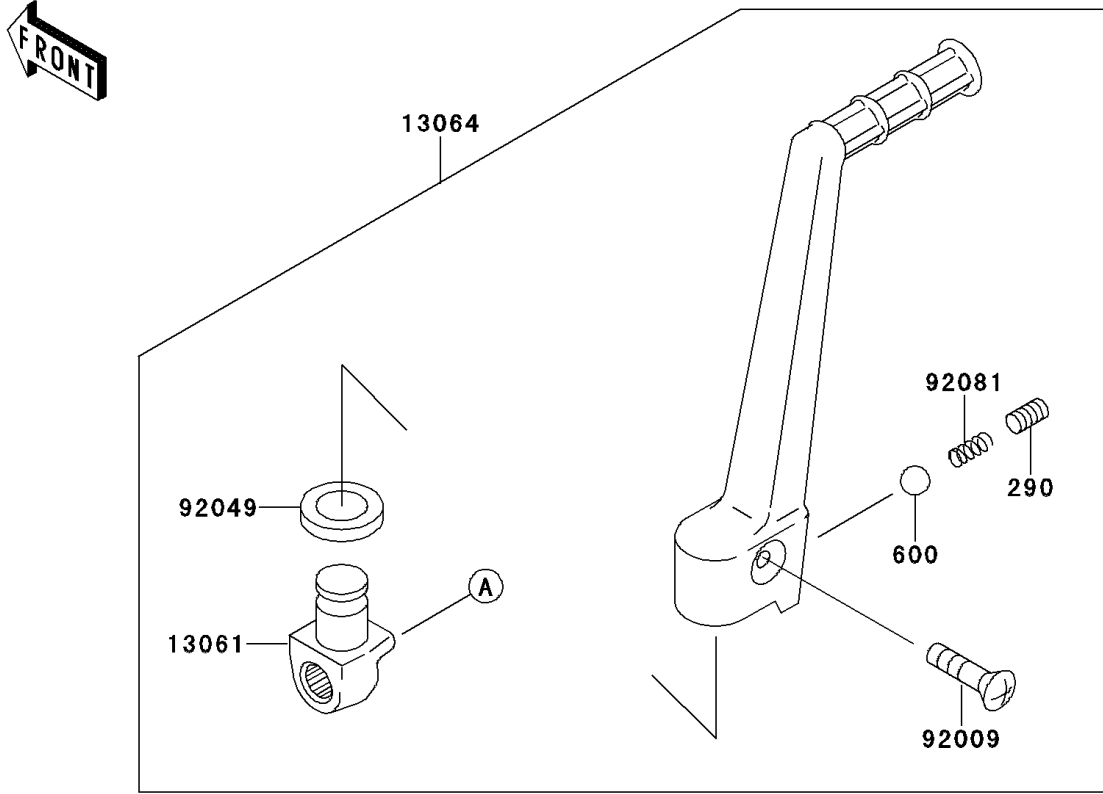

2001 KX125 PARTS LIST

Kickstarter Mechanism

ITEM NAME	PART NUMBER	QUANTITY
BOLT-FLANGED-SMALL (Ref # 132)	132G0616	1
SCREW-SET-SOCKET (Ref # 290)	290P0808	1
CIRCLIP-TYPE-C,16MM (Ref # 480)	480J1600	3
CIRCLIP-TYPE-C,17MM (Ref # 480A)	480J1700	1
BALL-STEEL,1/4" (Ref # 600)	600A0800	1
BOSS,KICK (Ref # 13061)	13061-1713	1
LEVER-ASSY-KICK,PEDAL (Ref # 13064)	13064-1189	1
SHAFT-KICK (Ref # 13066)	13066-1101	1
GUIDE,KICK SPRING (Ref # 13070)	13070-1007	1
RATCHET (Ref # 13078)	13078-1052	1
GUIDE-KICK (Ref # 13206)	13206-1061	1
GEAR-SPUR,KICK,30T (Ref # 59051)	59051-1364	1
GEAR-SPUR,IDLER,31T (Ref # 59051A)	59051-1365	1
SCREW,6X27 (Ref # 92009)	92009-1607	1
SEAL-OIL,KICK PEDAL (Ref # 92049)	92049-1387	1
SPRING,KICK PEDAL (Ref # 92081)	92081-020	1
SPRING,RATCHET (Ref # 92081A)	92081-122	1
SPRING,KICKSTARTER (Ref # 92081B)	92081-1768	1
BOLT,SOCKET,6X16 (Ref # 92150)	92150-1673	1
WASHER,KICKSHAFT (Ref # 92200)	92200-1209	3