

2021 MULE PRO-DXT™ EPS DIESEL PARTS DIAGRAM

Fuel Filter

F2411

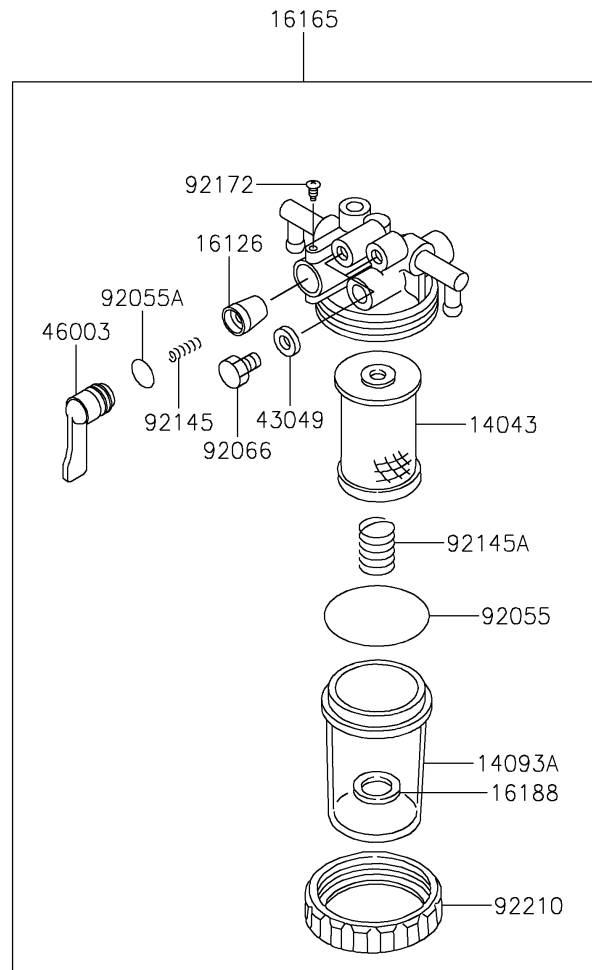
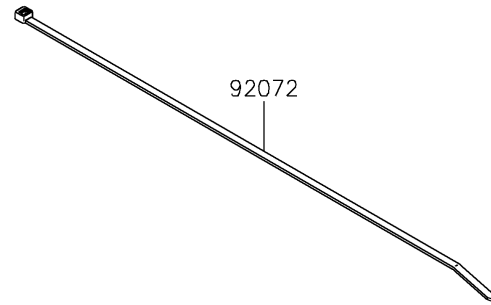
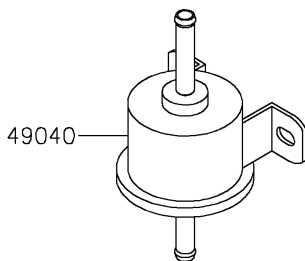
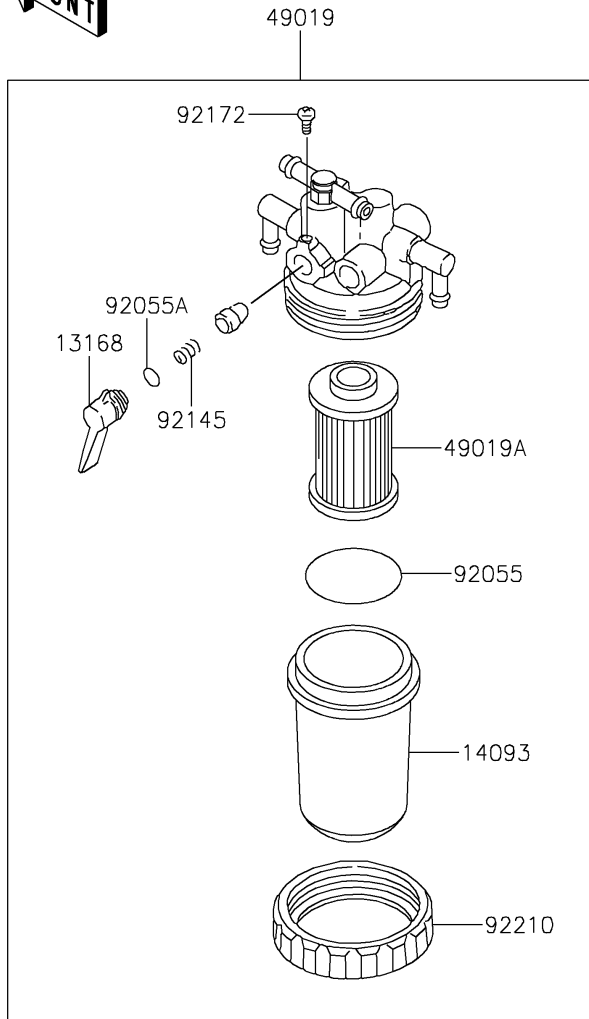

2021 MULE PRO-DXT™ EPS DIESEL PARTS LIST

Fuel Filter

ITEM NAME	PART NUMBER	QUANTITY
LEVER (Ref # 13168)	13168-0845	1
FILTER (Ref # 14043)	14043-0018	1
COVER (Ref # 14093)	14093-0452	1
COVER (Ref # 14093A)	14093-0453	1
VALVE (Ref # 16126)	16126-0738	1
SEPARATOR,WATER (Ref # 16165)	16165-0012	1
FLOAT (Ref # 16188)	16188-0038	1
PACKING,6X1 (Ref # 43049)	43049-0046	2
HANDLE (Ref # 46003)	46003-0665	1
FILTER-FUEL (Ref # 49019)	49019-0020	1
FILTER-FUEL,ELEMENT (Ref # 49019A)	49019-0026	1
PUMP-FUEL (Ref # 49040)	49040-0747	1
RING-O (Ref # 92055)	92055-0864	2
RING-O (Ref # 92055A)	92055-0865	2
PLUG (Ref # 92066)	92066-0856	2
BAND,L=292.1 (Ref # 92072)	92072-3509	1
SPRING,VALVE (Ref # 92145)	92145-1718	2
SPRING (Ref # 92145A)	92145-1719	1
SCREW (Ref # 92172)	92172-0992	2
NUT,FILTER (Ref # 92210)	92210-1494	2