

# 2020 VULCAN® 1700 VAQUERO® ABS PARTS DIAGRAM

## Gear Change Mechanism

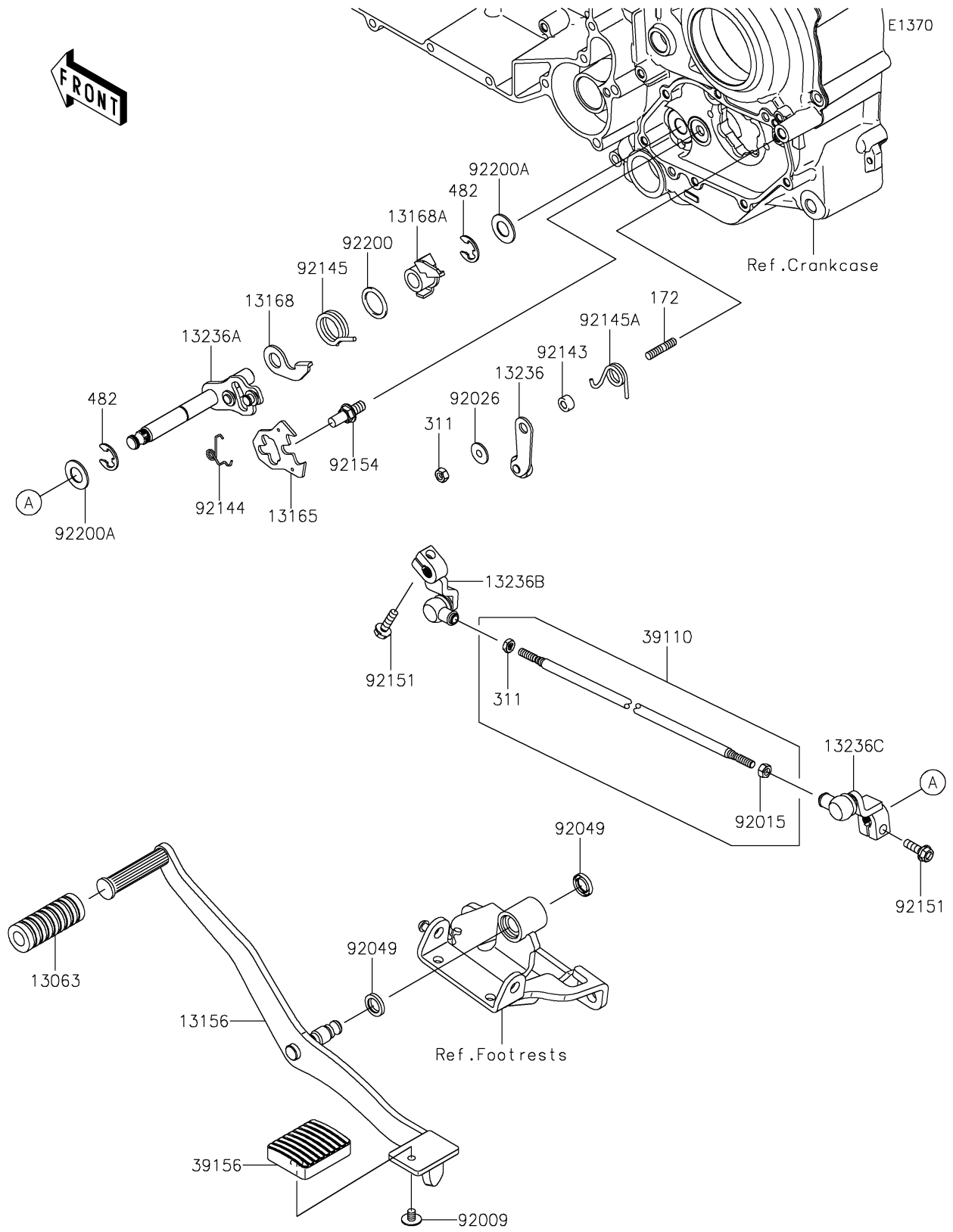

## 2020 VULCAN® 1700 VAQUERO® ABS PARTS LIST

### Gear Change Mechanism

ITEM NAME	PART NUMBER	QUANTITY
DAMPER,PEDAL (Ref # 13063)	13063-002	1
LEVER-CHANGE (Ref # 13156)	13156-0555	1
PAWL (Ref # 13165)	13165-0001	1
LEVER (Ref # 13168)	13168-0009	1
LEVER (Ref # 13168A)	13168-0010	1
LEVER-COMP,POSITION (Ref # 13236)	13236-0059	1
LEVER-COMP,CHANGE (Ref # 13236A)	13236-0153	1
LEVER-COMP,FR LINKAGE (Ref # 13236B)	13236-0154	1
LEVER-COMP,RR LINKAGE (Ref # 13236C)	13236-0155	1
BOLT-STUD,6X18 (Ref # 172)	172BA0618	1
NUT-HEX,6MM (Ref # 311)	311BA0600	2
ROD-ASSY-TIE (Ref # 39110)	39110-0034	1
PAD (Ref # 39156)	39156-1641	1
CIRCLIP-TYPE-E,12MM (Ref # 482)	482J0200	2
SCREW,6X8 (Ref # 92009)	92009-1677	1
NUT,LEFT HANDED,6MM (Ref # 92015)	92015-1125	1
SPACER (Ref # 92026)	92026-1217	1
SEAL-OIL,VB13193 (Ref # 92049)	92049-1398	2
COLLAR (Ref # 92143)	92143-1595	1
SPRING (Ref # 92144)	92144-1029	1
SPRING,24X3.2 (Ref # 92145)	92145-0661	1
SPRING,16X3 (Ref # 92145A)	92145-0718	1
BOLT,FLANGED,6X20 (Ref # 92151)	92151-1226	2
BOLT,RETURN SPRING (Ref # 92154)	92154-1838	1
WASHER,20.5X27X1.6 (Ref # 92200)	92200-0018	1
WASHER,13.4X25X1.6 (Ref # 92200A)	92200-0477	2