

2020 VULCAN® 1700 VAQUERO® ABS PARTS DIAGRAM

Front Brake

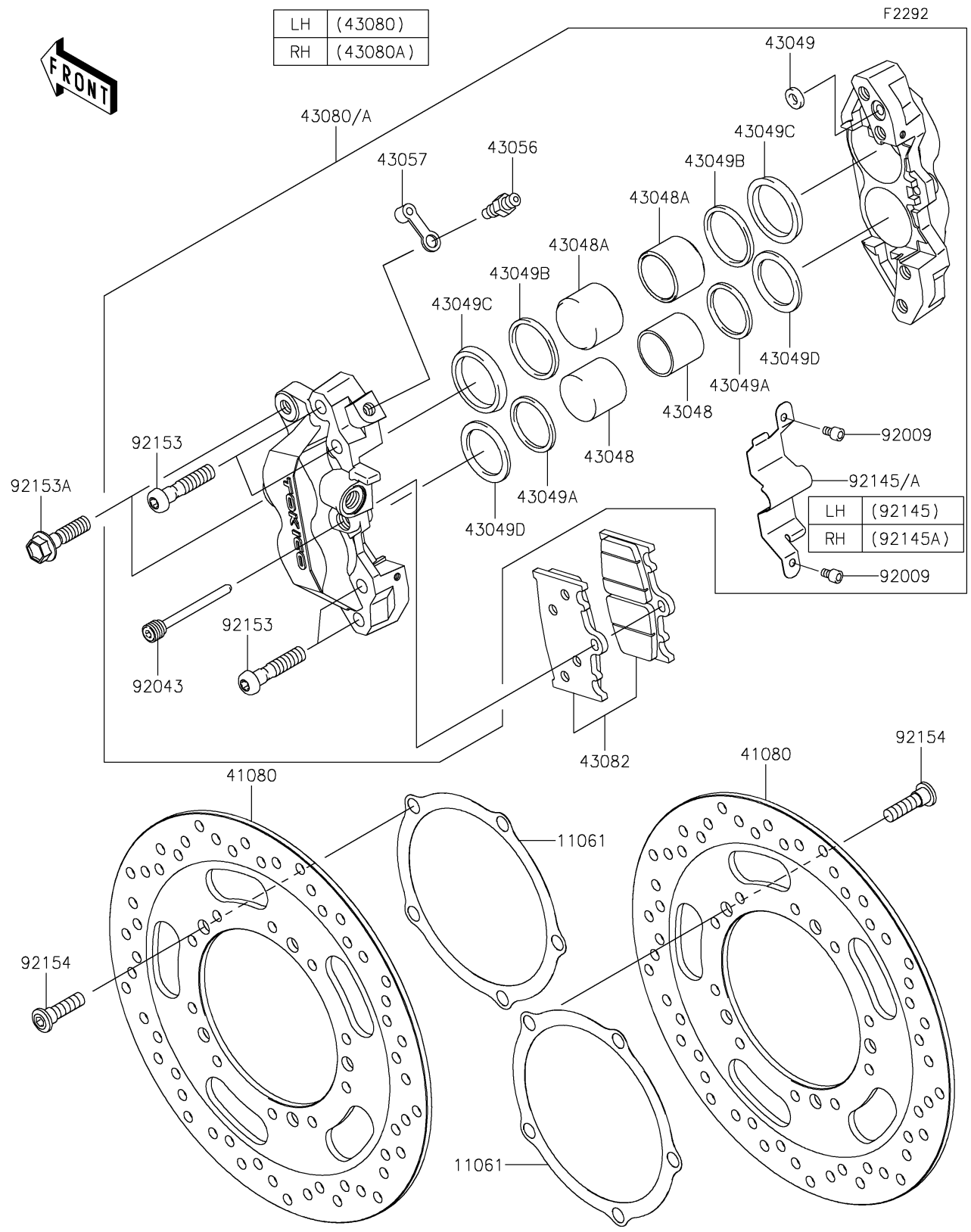

2020 VULCAN® 1700 VAQUERO® ABS PARTS LIST

Front Brake

ITEM NAME	PART NUMBER	QUANTITY
GASKET,DISC PLATE (Ref # 11061)	11061-0894	2
DISC,FR,BLACK (Ref # 41080)	41080-0181-11H	2
PISTON-CALIPER,DIA=26.97 (Ref # 43048)	43048-1078	4
PISTON-CALIPER,DIA=30.2 (Ref # 43048A)	43048-1098	4
PACKING,SEAL,6.5X11.5X2.2 (Ref # 43049)	43049-1004	2
PACKING,PISTON (Ref # 43049A)	43049-1055	4
PACKING (Ref # 43049B)	43049-1068	4
PACKING,PISTON SEAL (Ref # 43049C)	43049-1092	4
PACKING,PISTON SEAL (Ref # 43049D)	43049-1096	4
BREATHER-BRAKE (Ref # 43056)	43056-0007	2
CAP-BREATHER (Ref # 43057)	43057-003	2
CALIPER-SUB-ASSY,FR,LH,BLACK (Ref # 43080)	43080-0073-DJ	1
CALIPER-SUB-ASSY,FR,RH,BLACK (Ref # 43080A)	43080-0074-DJ	1
PAD-ASSY-BRAKE (Ref # 43082)	43082-0016	2
BOLT,SOCKET,4X6 (Ref # 92009)	92009-1758	4
PIN,PAD (Ref # 92043)	92043-1683	2
SPRING,COVER,LH (Ref # 92145)	92145-1503	1
SPRING,COVER,RH (Ref # 92145A)	92145-1504	1
BOLT,SOCKET,8X40 (Ref # 92153)	92153-0360	8
BOLT,FLANGED,8X30 (Ref # 92153A)	92153-1089	4
BOLT,SOCKET,8X30 (Ref # 92154)	92154-1865	10