

2019 NINJA® ZX™-14R ABS PARTS DIAGRAM

Footrests

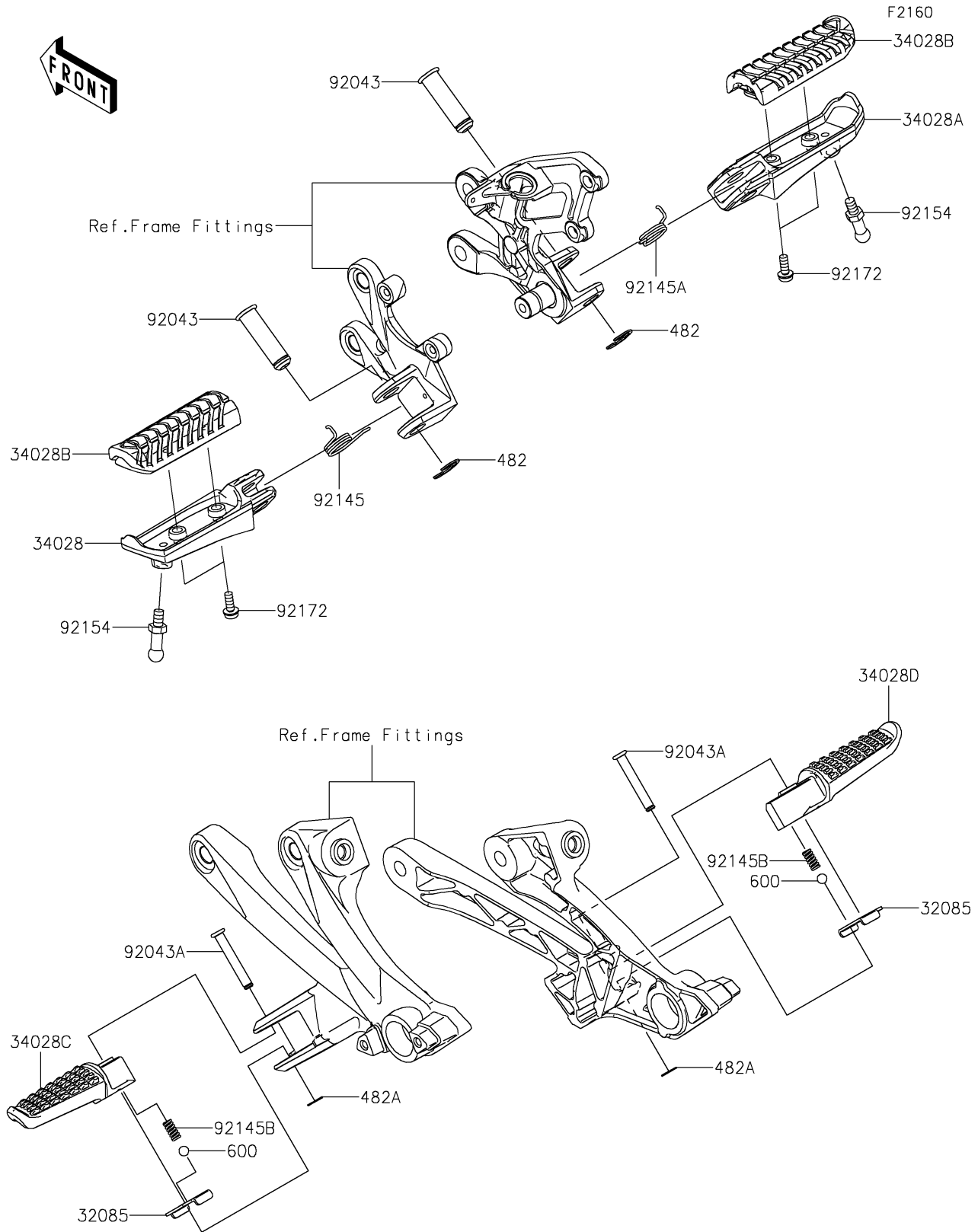

2019 NINJA® ZX™-14R ABS PARTS LIST

Footrests

ITEM NAME	PART NUMBER	QUANTITY
STOPPER,REAR STEP (Ref # 32085)	32085-0046	2
STEP,FR,LH (Ref # 34028)	34028-0031	1
STEP,FR,RH (Ref # 34028A)	34028-0032	1
STEP,FR,RUBBER (Ref # 34028B)	34028-0322	2
STEP,RR,LH (Ref # 34028C)	34028-0329	1
STEP,RR,RH (Ref # 34028D)	34028-0330	1
CIRCLIP-TYPE-E,10MM (Ref # 482)	482EA0100	2
CIRCLIP-TYPE-E (Ref # 482A)	482EA5000	2
BALL-STEEL,1/4 (Ref # 600)	600A0800	2
PIN,12X42.5 (Ref # 92043)	92043-1594	2
PIN,6X40 (Ref # 92043A)	92043-1595	2
SPRING,STEP RETURN,LH (Ref # 92145)	92145-0360	1
SPRING,STEP RETURN,RH (Ref # 92145A)	92145-0361	1
SPRING (Ref # 92145B)	92145-1319	2
BOLT,BANK SENSOR,6X10 (Ref # 92154)	92154-1854	2
SCREW,5X14 (Ref # 92172)	92172-0976	4