

2020 NINJA® ZX™-14R ABS PARTS DIAGRAM

Chassis Electrical Equipment

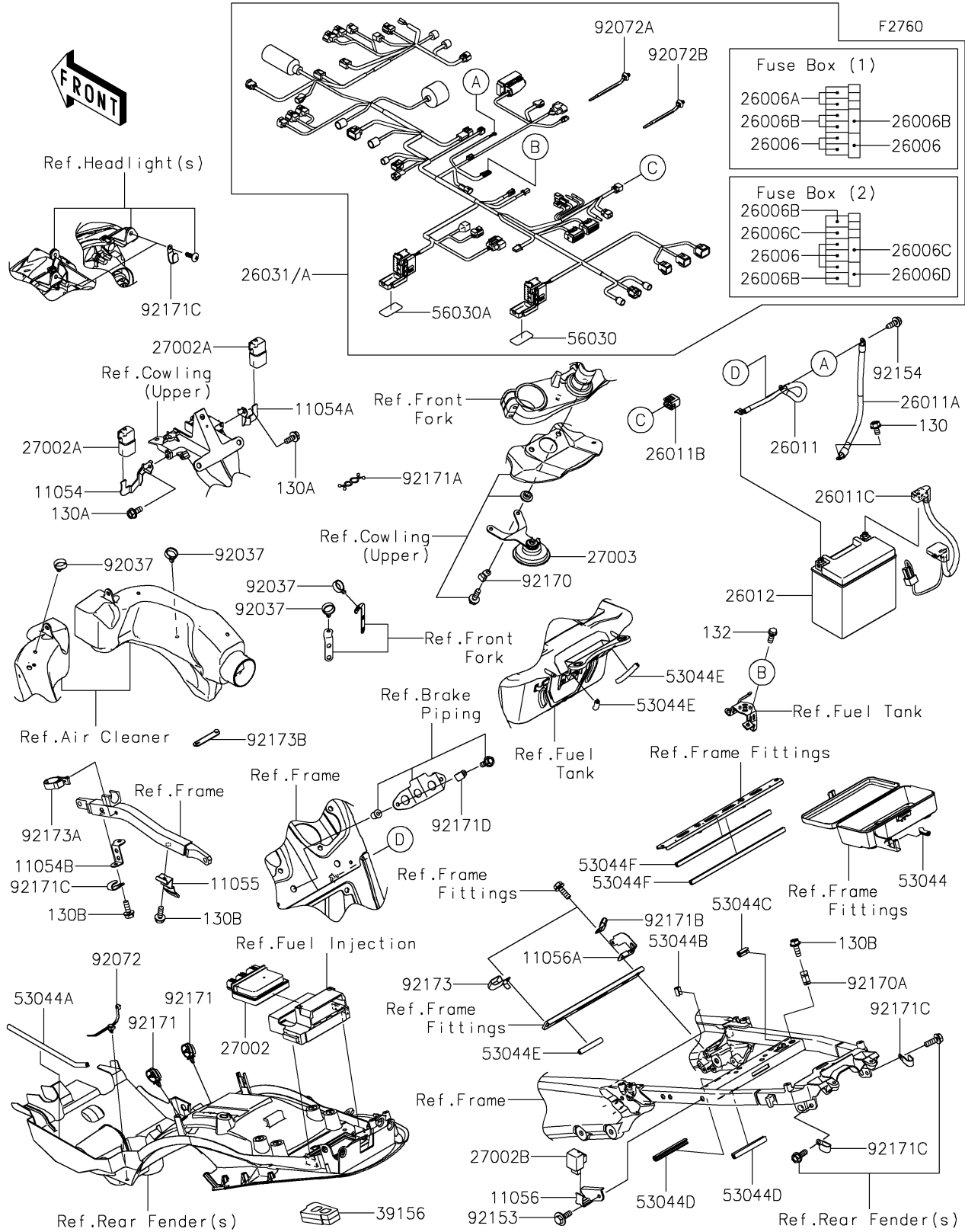

2020 NINJA® ZX™ -14R ABS PARTS LIST

Chassis Electrical Equipment

ITEM NAME	PART NUMBER	QUANTITY
BRACKET,RELAY,LH (Ref # 11054)	11054-0497	1
BRACKET,RELAY,RH (Ref # 11054A)	11054-0498	1
BRACKET,HARNESS (Ref # 11054B)	11054-0551	1
BRACKET,HARNESS (Ref # 11055)	11055-0411	1
BRACKET,SIGNAL LAMP RELAY (Ref # 11056)	11056-7989	1
BRACKET,HARNESS (Ref # 11056A)	11056-7991	1
FUSE,MINI BLADE,15A,BLUE (Ref # 26006)	26006-0001	6
FUSE,MINI BLADE,2A,GRAY (Ref # 26006A)	26006-0052	2
FUSE,MINI BLADE,10A,RED (Ref # 26006B)	26006-1078	5
FUSE,MINI BLADE,20A,YELLOW (Ref # 26006C)	26006-1079	2
FUSE,MINI BLADE,30A,GREEN (Ref # 26006D)	26006-1080	1
WIRE-LEAD,BATTERY(-) (Ref # 26011)	26011-0087	1
WIRE-LEAD,BATTERY(-) (Ref # 26011A)	26011-0255	1
WIRE-LEAD,CONNECTOR COVER (Ref # 26011B)	26011-0275	1
WIRE-LEAD,BATTERY(+)-STARTER (Ref # 26011C)	26011-0750	1
BATTERY,FTX14-BS,12V 12AH (Ref # 26012)	26012-0582	1
HARNESS,MAIN (Ref # 26031)	26031-1937	1
HARNESS,MAIN (Ref # 26031A)	26031-1938	1
RELAY-ASSY,BOX (Ref # 27002)	27002-0025	1
RELAY-ASSY (Ref # 27002A)	27002-1086	2
RELAY-ASSY,TURN SIGNAL (Ref # 27002B)	27002-1101	1
HORN (Ref # 27003)	27003-0069	1
PAD (Ref # 39156)	39156-0846	1
TRIM,L=30 (Ref # 53044)	53044-0001	1
TRIM,L=220 (Ref # 53044A)	53044-0022	1
TRIM,L=15 (Ref # 53044B)	53044-0025	2
TRIM,L=22 (Ref # 53044C)	53044-0031	1
TRIM,L=85 (Ref # 53044D)	53044-0561	2
TRIM,L=60 (Ref # 53044E)	53044-1249	3

2020 NINJA® ZX™ -14R ABS PARTS LIST

Chassis Electrical Equipment

ITEM NAME	PART NUMBER	QUANTITY
TRIM,AIR DUCT COVER (Ref # 53044F)	53044-1265	2
LABEL,FUSE BOX2 (Ref # 56030)	56030-0769	1
LABEL,FUSE BOX1 (Ref # 56030A)	56030-0960	1
CLAMP,HOSE (Ref # 92037)	92037-1827	4
BAND (Ref # 92072)	92072-0066	1
BAND (Ref # 92072A)	92072-1392	7
BAND,OS170-FT7(BLACK) (Ref # 92072B)	92072-1414	2
BAND,OS170-FT7(BLACK) (Ref # 92072B)	92072-1414	3
BOLT-FLANGED,6X10 (Ref # 130)	130BA0610	1
BOLT-FLANGED,6X14 (Ref # 130A)	130BA0614	2
BOLT-FLANGED,6X16 (Ref # 130B)	130BA0616	3
BOLT-FLANGED-SMALL,6X16 (Ref # 132)	132BA0616	1
BOLT,6X20 (Ref # 92153)	92153-0562	1
BOLT,FLANGED,6X16 (Ref # 92154)	92154-0551	1
CLAMP (Ref # 92170)	92170-1577	1
CLAMP (Ref # 92170A)	92170-1925	1
CLAMP,CLIP,DIA=20 (Ref # 92171)	92171-0068	2
CLAMP (Ref # 92171A)	92171-0476	1
CLAMP (Ref # 92171B)	92171-0689	1
CLAMP (Ref # 92171C)	92171-0739	5
CLAMP (Ref # 92171D)	92171-0813	1
CLAMP,84MM (Ref # 92173)	92173-1008	1
CLAMP,CABLE,28MM (Ref # 92173A)	92173-1062	1
CLAMP (Ref # 92173B)	92173-1526	1