

2018 VULCAN® S ABS CAFE PARTS DIAGRAM

Front Master Cylinder

F2291

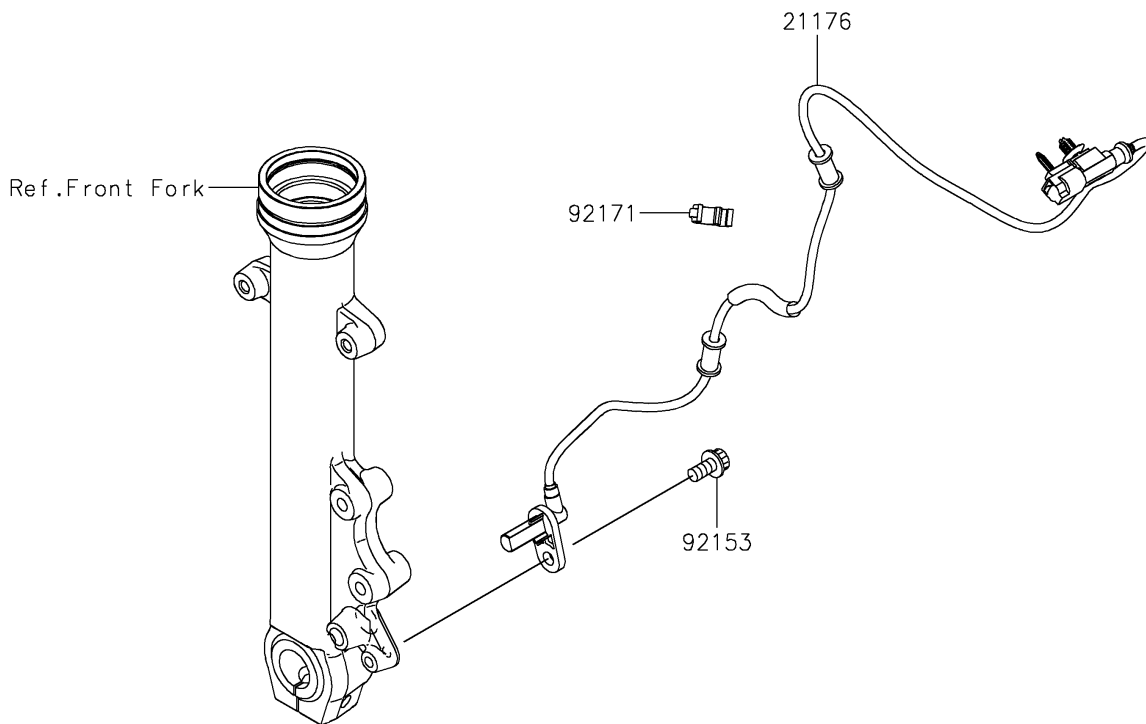
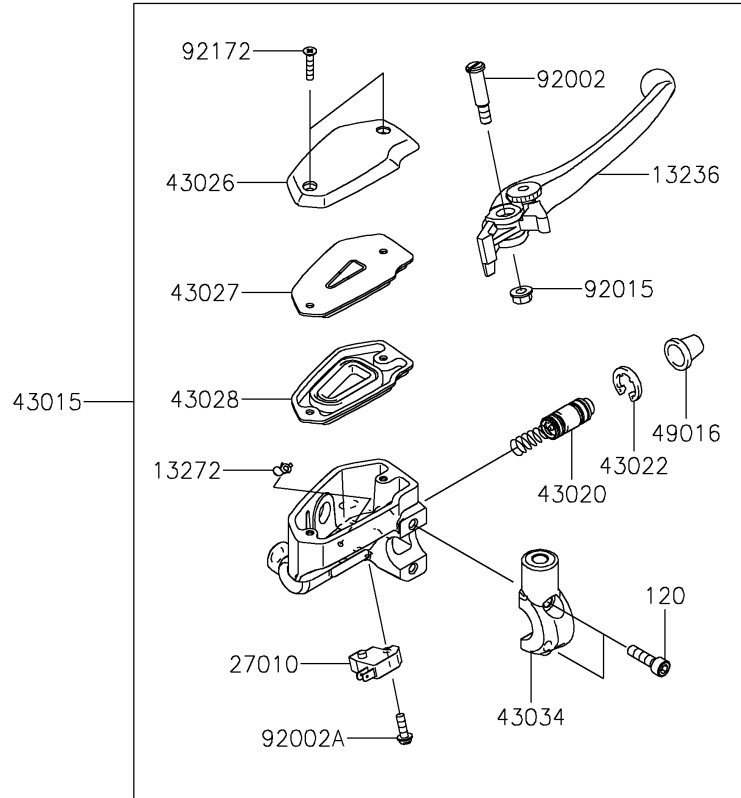

2018 VULCAN® S ABS CAFE PARTS LIST

Front Master Cylinder

ITEM NAME	PART NUMBER	QUANTITY
BOLT-SOCKET,6X22 (Ref # 120)	120CB0622	2
LEVER-COMP,FRONT BRAKE (Ref # 13236)	13236-0140	1
PLATE (Ref # 13272)	13272-0573	1
SENSOR,FR WHEEL SPEED (Ref # 21176)	21176-0804	1
SWITCH,BRAKE (Ref # 27010)	27010-0762	1
CYLINDER-ASSY-MASTER,FR (Ref # 43015)	43015-0606	1
PISTON-COMP-BRAKE (Ref # 43020)	43020-1095	1
STOPPER-BRAKE,PISTON (Ref # 43022)	43022-1010	1
CAP-BRAKE (Ref # 43026)	43026-0019	1
PLATE-DIAPHRAGM (Ref # 43027)	43027-0008	1
DIAPHRAGM (Ref # 43028)	43028-0015	1
HOLDER-BRAKE,MASTER CYLINDER (Ref # 43034)	43034-0049	1
COVER-SEAL,MASTER CYLINDER (Ref # 49016)	49016-1044	1
BOLT,LEVER SET,BLACK (Ref # 92002)	92002-1322	1
BOLT,SCREW,4X12 (Ref # 92002A)	92002-1323	1
NUT,FLANGED,6MM (Ref # 92015)	92015-1528	1
BOLT,SOCKET,8X16 (Ref # 92153)	92153-0327	1
CLAMP,BRAKE HOSE (Ref # 92171)	92171-1819	1
SCREW,4X20 (Ref # 92172)	92172-0320	2