

# 1994 KX250 PARTS DIAGRAM

Fuel Tank

F 2410

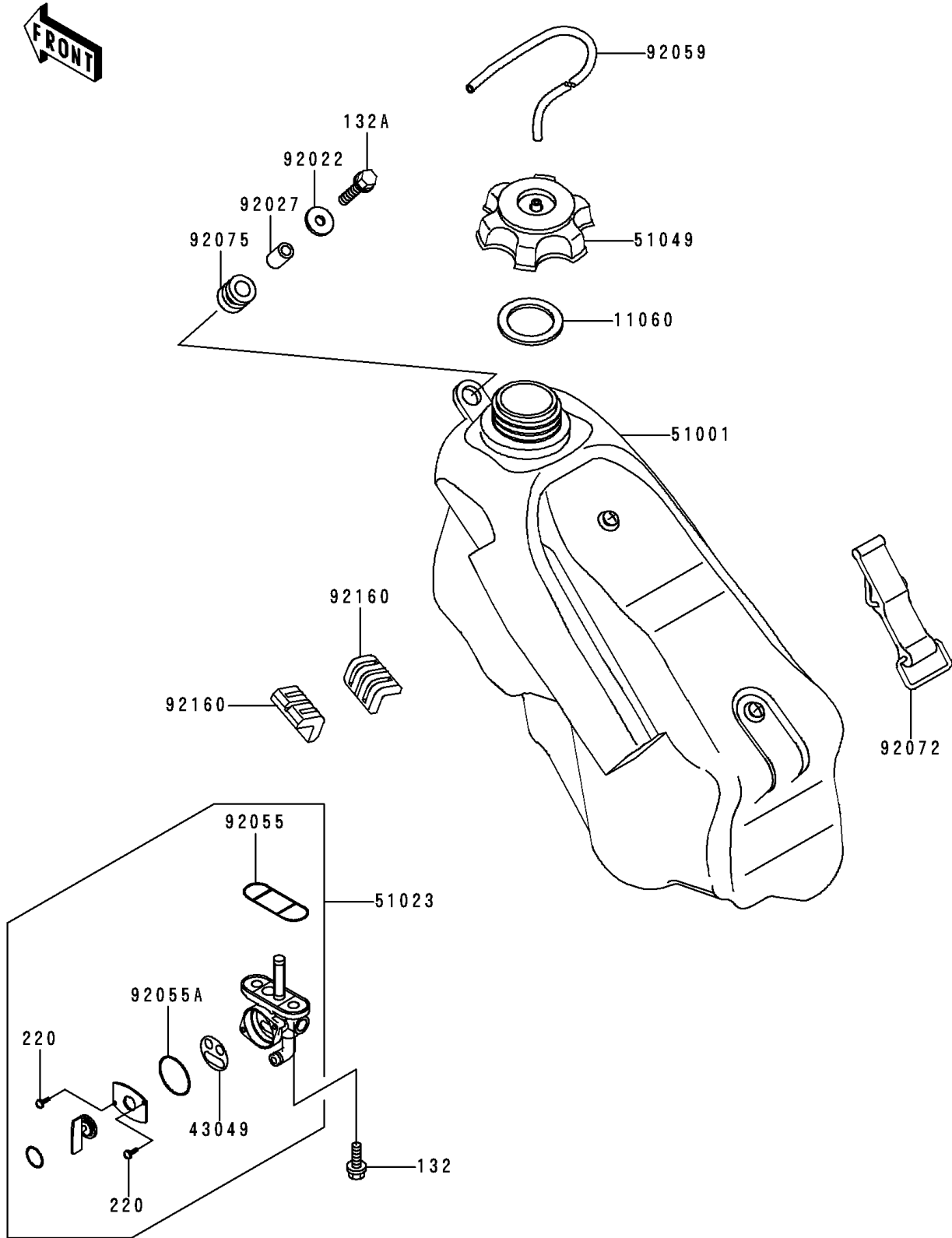

# 1994 KX250 PARTS LIST

## Fuel Tank

ITEM NAME	PART NUMBER	QUANTITY
BOLT-FLANGED-SMALL (Ref # 132)	132G0612	2
BOLT-FLANGED-SMALL (Ref # 132A)	132G0625	1
SCREW-PAN-CROS (Ref # 220)	220B0308	2
GASKET,FUEL TANK CAP (Ref # 11060)	11060-1340	1
PACKING,TAP VALVE (Ref # 43049)	43049-1066	1
TANK-COMP-FUEL,F.BLACK (Ref # 51001)	51001-1388-6Z	1
TAP-ASSY,FUEL (Ref # 51023)	51023-1182	1
CAP-TANK,FUEL (Ref # 51049)	51049-1089	1
WASHER,6.5X24X2 (Ref # 92022)	92022-1690	1
COLLAR,6.8X10X14 (Ref # 92027)	92027-1966	1
RING-O,FUEL TAP PACKING (Ref # 92055)	92055-1112	1
RING-O,TAP LEVER (Ref # 92055A)	92055-1419	1
TUBE,5X9X350 (Ref # 92059)	92059-1265	1
BAND,FUEL TANK (Ref # 92072)	92072-1229	1
DAMPER (Ref # 92075)	92075-1787	1
DAMPER,FUEL TANK (Ref # 92160)	92160-1328	2