

2020 KLX® 230 PARTS DIAGRAM

Fuel Injection

E1530

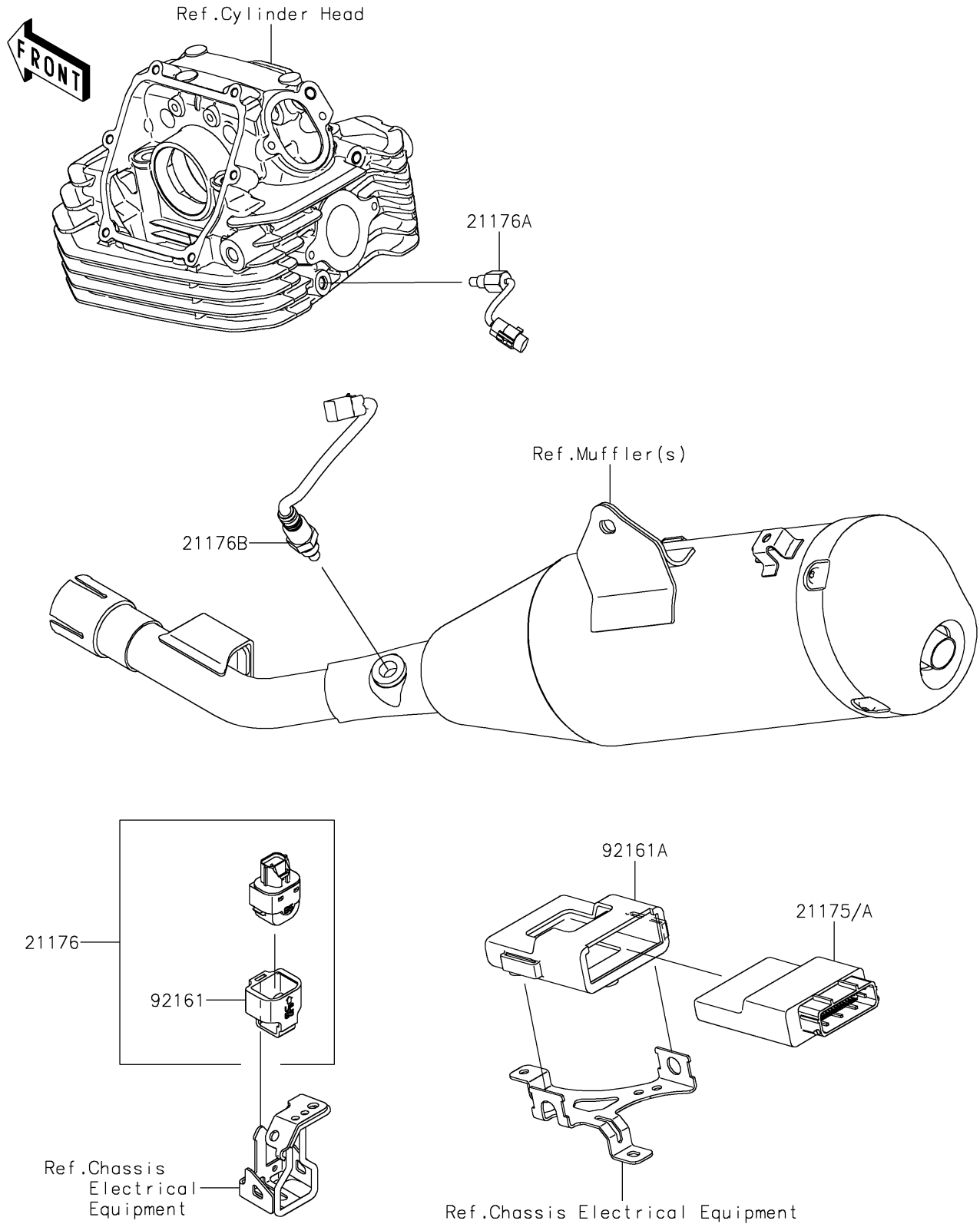

2020 KLX® 230 PARTS LIST

Fuel Injection

ITEM NAME	PART NUMBER	QUANTITY
CONTROL UNIT-ELECTRONIC (Ref # 21175)	21175-1508	1
CONTROL UNIT-ELECTRONIC (Ref # 21175A)	21175-1509	1
SENSOR,VEHICLE-DOWN (Ref # 21176)	21176-0704	1
SENSOR,ENGINE TEMP (Ref # 21176A)	21176-0898	1
SENSOR,OXYGEN (Ref # 21176B)	21176-0899	1
DAMPER (Ref # 92161)	92161-0951	1
DAMPER,ECU (Ref # 92161A)	92161-2101	1