

2021 Ninja® 650 PARTS DIAGRAM

Handlebar

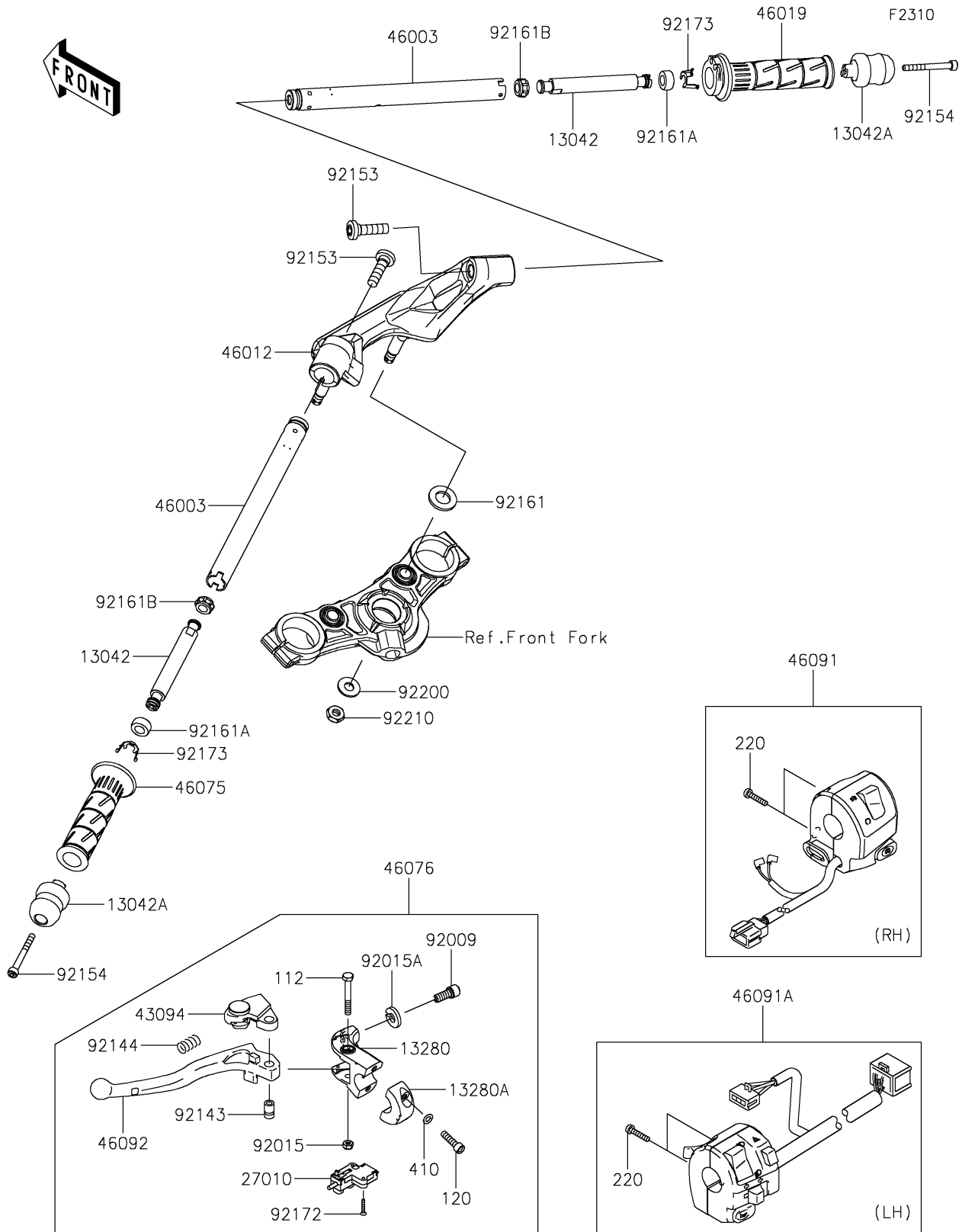

2021 Ninja® 650 PARTS LIST

Handlebar

ITEM NAME	PART NUMBER	QUANTITY
BOLT-UPSET,6X45 (Ref # 112)	112BB0645	1
BOLT-SOCKET,6X25 (Ref # 120)	120CB0625	2
WEIGHT,INNER (Ref # 13042)	13042-0799	2
WEIGHT,OUTER (Ref # 13042A)	13042-0800	2
HOLDER,CLUTCH LEVER (Ref # 13280)	13280-0306	1
HOLDER,CLUTCH LEVER (Ref # 13280A)	13280-0319	1
SCREW-PAN-CROS,5X25 (Ref # 220)	220AB0525	4
SWITCH,CLUTCH (Ref # 27010)	27010-0849	1
WASHER-PLAIN-SMALL,6MM (Ref # 410)	410AB0600	2
ADJUSTER (Ref # 43094)	43094-0009	1
HANDLE,F.S.BLACK (Ref # 46003)	46003-0672-18R	2
HOLDER-HANDLE,F.S.BLACK (Ref # 46012)	46012-0385-18R	1
GRIP-ASSY,THROTTLE (Ref # 46019)	46019-0060	1
GRIP,HANDLE,LH (Ref # 46075)	46075-0564	1
LEVER-ASSY-GRIP (Ref # 46076)	46076-0166	1
HOUSING-ASSY-CONTROL,RH (Ref # 46091)	46091-0488	1
HOUSING-ASSY-CONTROL,LH (Ref # 46091A)	46091-0489	1
LEVER-GRIP,CLUTCH (Ref # 46092)	46092-0569	1
SCREW,CABLE ADJUST,8MM,BLACK (Ref # 92009)	92009-1134	1
NUT,LOCK,6MM,BLACK (Ref # 92015)	92015-1191	1
NUT,CABLE ADJUST LOCK,8MM,BLK (Ref # 92015A)	92015-1197	1
COLLAR (Ref # 92143)	92143-1379	1
SPRING (Ref # 92144)	92144-1467	1
BOLT,SOCKET,10X37 (Ref # 92153)	92153-1440	2
BOLT,SOCKET,6X55 (Ref # 92154)	92154-1299	2
DAMPER (Ref # 92161)	92161-0037	2
DAMPER,10X20X10 (Ref # 92161A)	92161-1850	2
DAMPER,10X16X10,INNER (Ref # 92161B)	92161-1930	2
SCREW,3X16 (Ref # 92172)	92172-0183	2

2021 Ninja® 650 PARTS LIST

Handlebar

ITEM NAME	PART NUMBER	QUANTITY
CLAMP,WEIGHT (Ref # 92173)	92173-2293	2
WASHER,10.5X24X2 (Ref # 92200)	92200-1844	2
NUT,LOCK,10MM (Ref # 92210)	92210-0784	2