

2021 NINJA® 650 PARTS DIAGRAM

Suspension/Shock Absorber

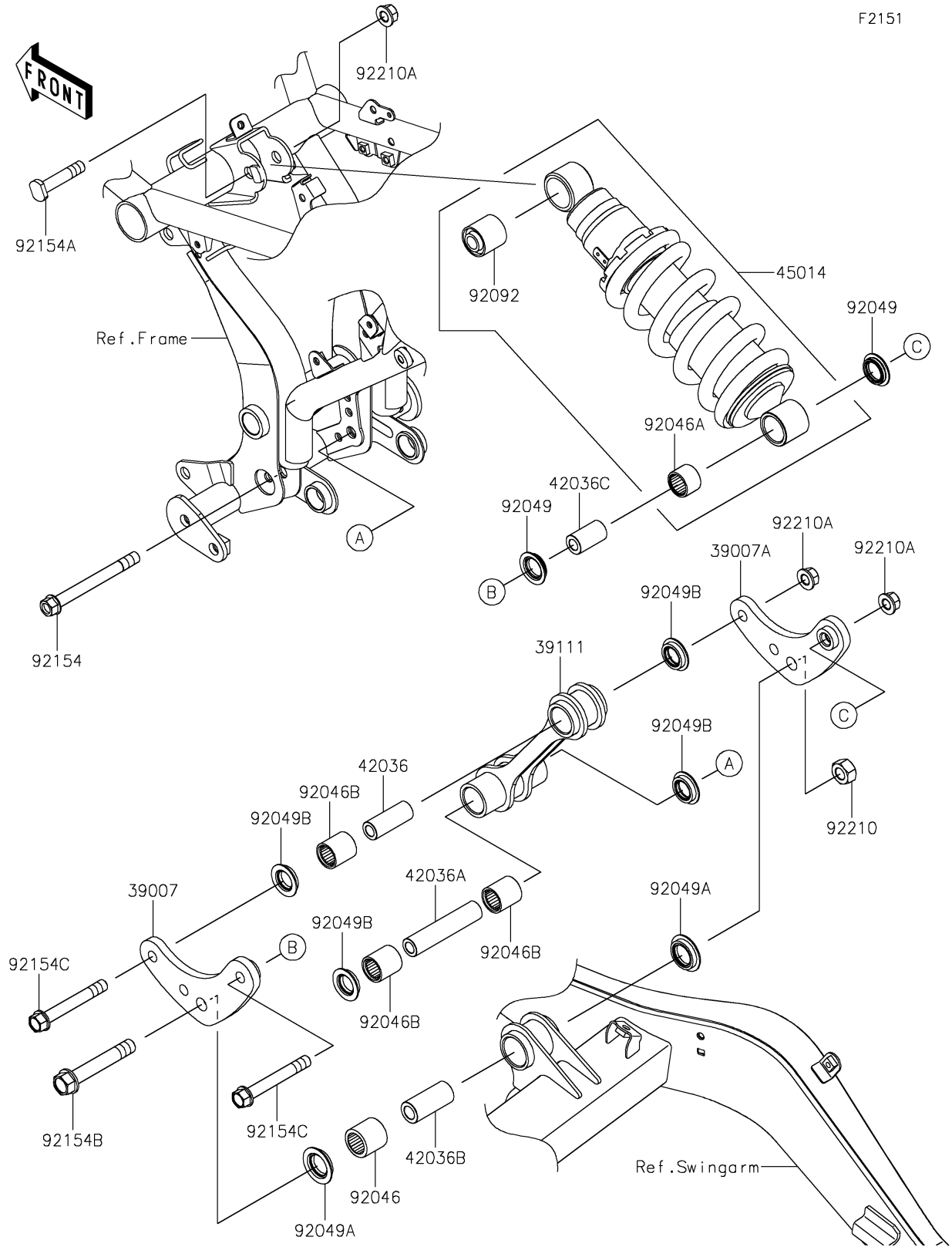

2021 NINJA® 650 PARTS LIST

Suspension/Shock Absorber

ITEM NAME	PART NUMBER	QUANTITY
ARM-SUSP,LH (Ref # 39007)	39007-0401	1
ARM-SUSP,RH (Ref # 39007A)	39007-0402	1
ROD-TIE (Ref # 39111)	39111-0343	1
SLEEVE,10.1X17X44.5 (Ref # 42036)	42036-0718	1
SLEEVE,10.1X17X79.8 (Ref # 42036A)	42036-0787	1
SLEEVE,12.1X20X44.5 (Ref # 42036B)	42036-0788	1
SLEEVE,10.1X18X32 (Ref # 42036C)	42036-1344	1
SHOCKABSORBER,P.SILVER (Ref # 45014)	45014-0565-458	1
BEARING-NEEDLE,7E-HVS20X27X25 (Ref # 92046)	92046-1236	1
BEARING-NEEDLE,SFYZM182417 (Ref # 92046A)	92046-1272	1
BEARING-NEEDLE,SFYZM172425 (Ref # 92046B)	92046-1273	3
SEAL-OIL (Ref # 92049)	92049-0133	2
SEAL-OIL,ARM (Ref # 92049A)	92049-1109	2
SEAL-OIL,MHA17245.7F (Ref # 92049B)	92049-1223	4
BUSHING-RUBBER (Ref # 92092)	92092-1058	1
BOLT,FLANGED,10X100 (Ref # 92154)	92154-1257	1
BOLT,10X50 (Ref # 92154A)	92154-2165	1
BOLT,FLANGED,12X75 (Ref # 92154B)	92154-2166	1
BOLT,FLANGED,10X75 (Ref # 92154C)	92154-2226	2
NUT,LOCK,12MM (Ref # 92210)	92210-0274	1
NUT,LOCK,FLANGED,10MM (Ref # 92210A)	92210-1139	3