

2021 NINJA® 650 ABS PARTS DIAGRAM

Brake Pedal/Torque Link

F2260

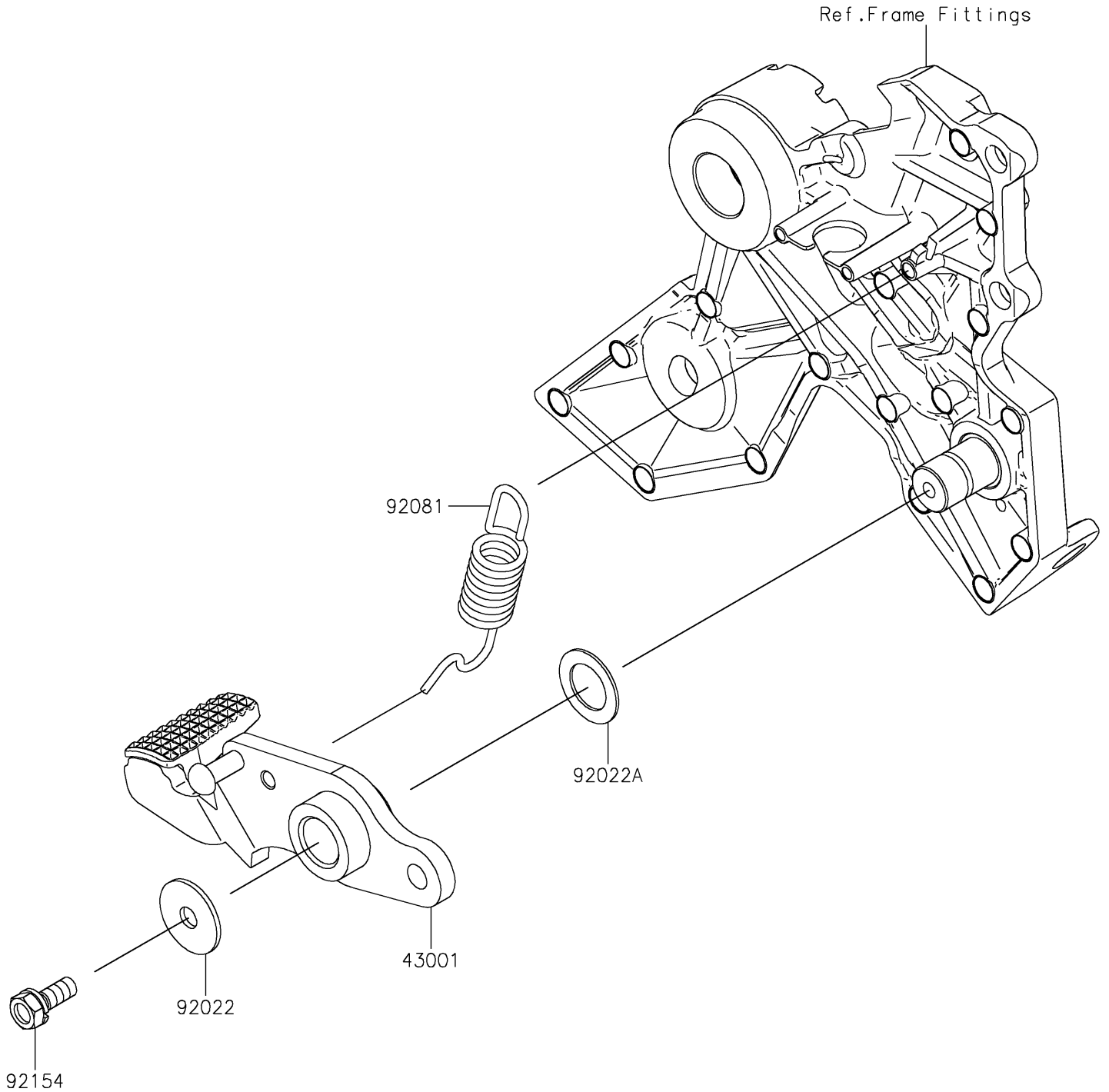

2021 NINJA® 650 ABS PARTS LIST

Brake Pedal/Torque Link

ITEM NAME	PART NUMBER	QUANTITY
-----------	-------------	----------