

2004 KX250 PARTS DIAGRAM

Front Fork

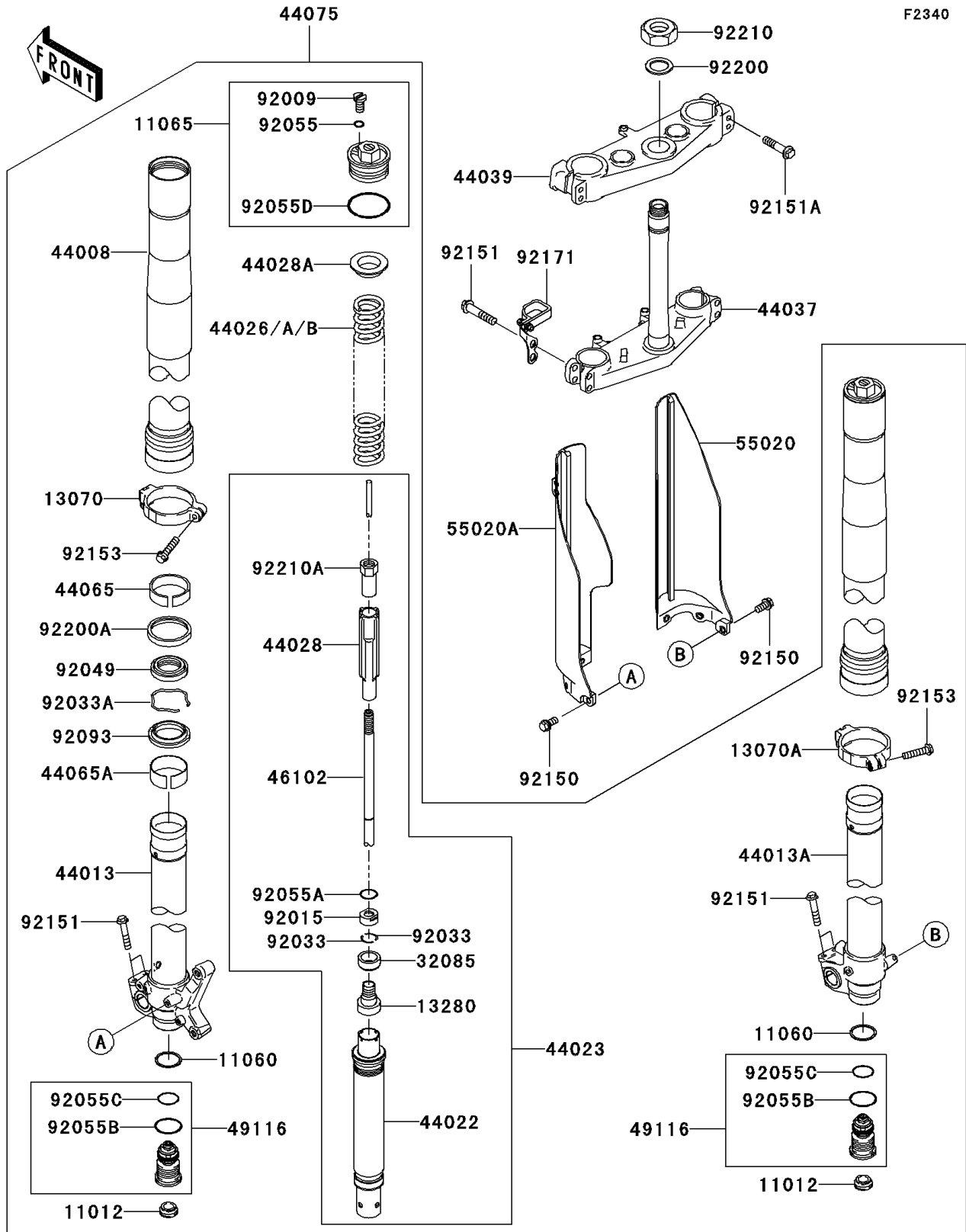

2004 KX250 PARTS LIST

Front Fork

ITEM NAME	PART NUMBER	QUANTITY
CAP (Ref # 11012)	11012-1692	2
GASKET (Ref # 11060)	11060-1707	2
CAP,FORK,TOP (Ref # 11065)	11065-1241	2
GUIDE,FORK,LH (Ref # 13070)	13070-0025	1
GUIDE,FORK,RH (Ref # 13070A)	13070-0027	1
HOLDER (Ref # 13280)	13280-1127	2
STOPPER (Ref # 32085)	32085-1323	2
PIPE-FORK OUTER,BRONZE (Ref # 44008)	44008-0004-JS	2
PIPE-FORK INNER,LH (Ref # 44013)	44013-0014	1
PIPE-FORK INNER,RH (Ref # 44013A)	44013-0015	1
CYLINDER-FORK (Ref # 44022)	44022-0006	2
CYLINDER-SET-FORK (Ref # 44023)	44023-0012	2
SPRING-FRONT FORK,K=0.43 (Ref # 44026)	44026-0011	2
SPRING-FRONT FORK,K=0.45 (Ref # 44026A)	44026-0013	2
SPRING-FRONT FORK,K=0.44 (Ref # 44026B)	44026-1769	2
GUIDE-FORK SPRING (Ref # 44028)	44028-0001	2
GUIDE-FORK SPRING (Ref # 44028A)	44028-1104	2
HOLDER-FORK UNDER (Ref # 44037)	44037-0007	1
HOLDER-FORK UPPER (Ref # 44039)	44039-1330	1
BUSHING-FRONT FORK (Ref # 44065)	44065-0006	2
BUSHING-FRONT FORK (Ref # 44065A)	44065-1140	2
DAMPER-SET-FORK,BRONZE (Ref # 44075)	44075-0011-JS	1
ROD,PISTON,ASSY (Ref # 46102)	46102-0026	2
VALVE-ASSY,FORK (Ref # 49116)	49116-0004	2
GUARD,FORK,RH,WHITE (Ref # 55020)	55020-0020-RZ	1
GUARD,FORK,LH,WHITE (Ref # 55020A)	55020-0060-RZ	1
SCREW (Ref # 92009)	92009-1884	2
NUT (Ref # 92015)	92015-1805	2
RING-SNAP (Ref # 92033)	92033-1271	4

2004 KX250 PARTS LIST

Front Fork

ITEM NAME	PART NUMBER	QUANTITY
RING-SNAP (Ref # 92033A)	92033-1329	2
SEAL-OIL (Ref # 92049)	92049-1599	2
RING-O (Ref # 92055)	92055-1441	2
RING-O (Ref # 92055A)	92055-1442	2
RING-O,FORK VALVE (Ref # 92055B)	92055-1547	2
RING-O,FORK VALVE (Ref # 92055C)	92055-1548	2
RING-O (Ref # 92055D)	92055-1677	2
SEAL,FORK OUTER TUBE (Ref # 92093)	92093-1566	2
BOLT,6X12 (Ref # 92150)	92150-1435	6
BOLT,FLANGED,8X40 (Ref # 92151)	92151-1877	8
BOLT,FLANGED,8X35 (Ref # 92151A)	92151-1878	4
BOLT,FLANGED,6X25 (Ref # 92153)	92153-0557	2
CLAMP,HOSE (Ref # 92171)	92171-1572	1
WASHER,25X36X1 (Ref # 92200)	92200-0023	1
WASHER (Ref # 92200A)	92200-0067	2
NUT,24MM (Ref # 92210)	92210-0066	1
NUT (Ref # 92210A)	92210-1177	2