

2021 MULE PRO-FXT™ EPS LE PARTS DIAGRAM

Chassis Electrical Equipment

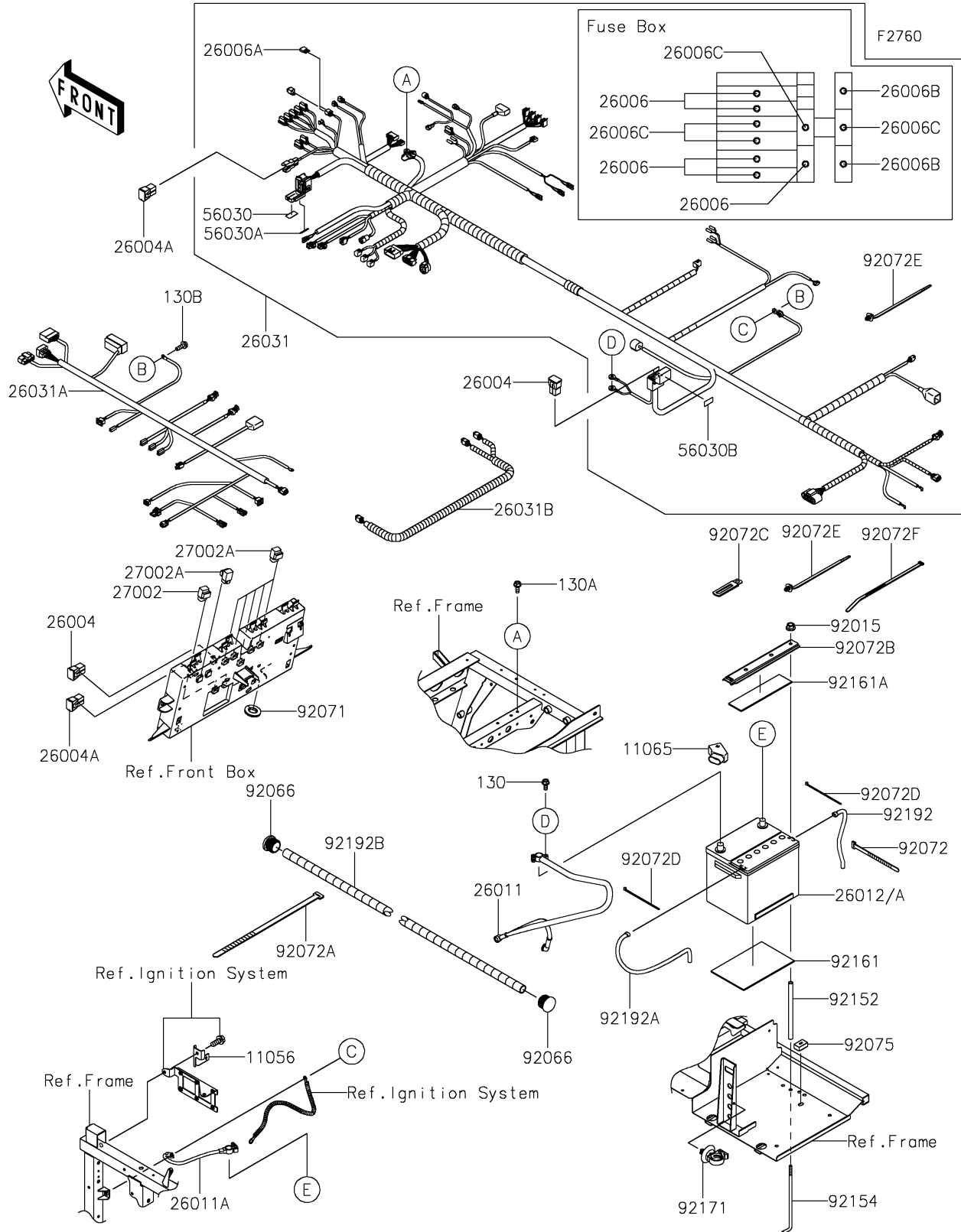

2021 MULE PRO-FXT™ EPS LE PARTS LIST

Chassis Electrical Equipment

ITEM NAME	PART NUMBER	QUANTITY
BRACKET (Ref # 11056)	11056-4397	1
CAP (Ref # 11065)	11065-0850	1
FUSE-ASSY,60A (Ref # 26004)	26004-0024	3
FUSE-ASSY,40A (Ref # 26004A)	26004-1093	2
FUSE,MINI BLADE,10A,RED (Ref # 26006)	26006-0009	5
FUSE,MINI BLADE,2A,GRAY (Ref # 26006A)	26006-0052	2
FUSE,MINI BLADE,30A,GREEN (Ref # 26006B)	26006-1080	2
FUSE,MINI BLADE,20A,YELLOW (Ref # 26006C)	26006-3704	4
WIRE-LEAD,BATTERY(+) (Ref # 26011)	26011-0851	1
WIRE-LEAD,BATTERY(-) (Ref # 26011A)	26011-0912	1
BATTERY,12V 32AH (Ref # 26012)	26012-0619	1
BATTERY,WET,(26R) (Ref # 26012A)	26012-7501	1
HARNESS,MAIN (Ref # 26031)	26031-2109	1
HARNESS (Ref # 26031A)	26031-2111	1
HARNESS,SUB (Ref # 26031B)	26031-2226	1
RELAY-ASSY (Ref # 27002)	27002-0022	2
RELAY-ASSY (Ref # 27002A)	27002-1062	6
LABEL,FUSE BOX1 (Ref # 56030)	56030-0850	1
LABEL,FUSE BOX2 (Ref # 56030A)	56030-0854	1
LABEL,FUSE CASE (Ref # 56030B)	56030-0891	1
NUT,FLANGED,8MM (Ref # 92015)	92015-1406	1
PLUG (Ref # 92066)	92066-0908	2
GROMMET,22X45X9 (Ref # 92071)	92071-0729	1
BAND,L=123 (Ref # 92072)	92072-030	1
BAND,L=218 (Ref # 92072A)	92072-032	2
BAND (Ref # 92072B)	92072-0767	1
BAND (Ref # 92072C)	92072-0770	4
BAND,92X2.4 (Ref # 92072D)	92072-0791	2
BAND,OS170-FT7(BLACK) (Ref # 92072E)	92072-1414	33

2021 MULE PRO-FXT™ EPS LE PARTS LIST

Chassis Electrical Equipment

ITEM NAME	PART NUMBER	QUANTITY
BAND,L=292.1 (Ref # 92072F)	92072-3509	13
BAND,L=292.1 (Ref # 92072F)	92072-3509	14
DAMPER (Ref # 92075)	92075-099	1
COLLAR,9.4X12.7X190.8 (Ref # 92152)	92152-1852	1
BOLT,BATTERY (Ref # 92154)	92154-1650	1
DAMPER (Ref # 92161)	92161-0578	1
DAMPER (Ref # 92161A)	92161-1753	1
CLAMP (Ref # 92171)	92171-0453	1
BOLT-FLANGED,6X14 (Ref # 130)	130BA0614	1
BOLT-FLANGED,6X16 (Ref # 130A)	130BA0616	1
BOLT-FLANGED,6X18 (Ref # 130B)	130BA0618	1
TUBE,BREATHER,7X10X240 (Ref # 92192)	92192-1646	1
TUBE,BREATHER,7X10X450 (Ref # 92192A)	92192-1694	1
TUBE,CONVOLUTED (Ref # 92192B)	92192-1814	1