

# 2020 Z900RS ABS PARTS DIAGRAM

Oil Pan

E1434

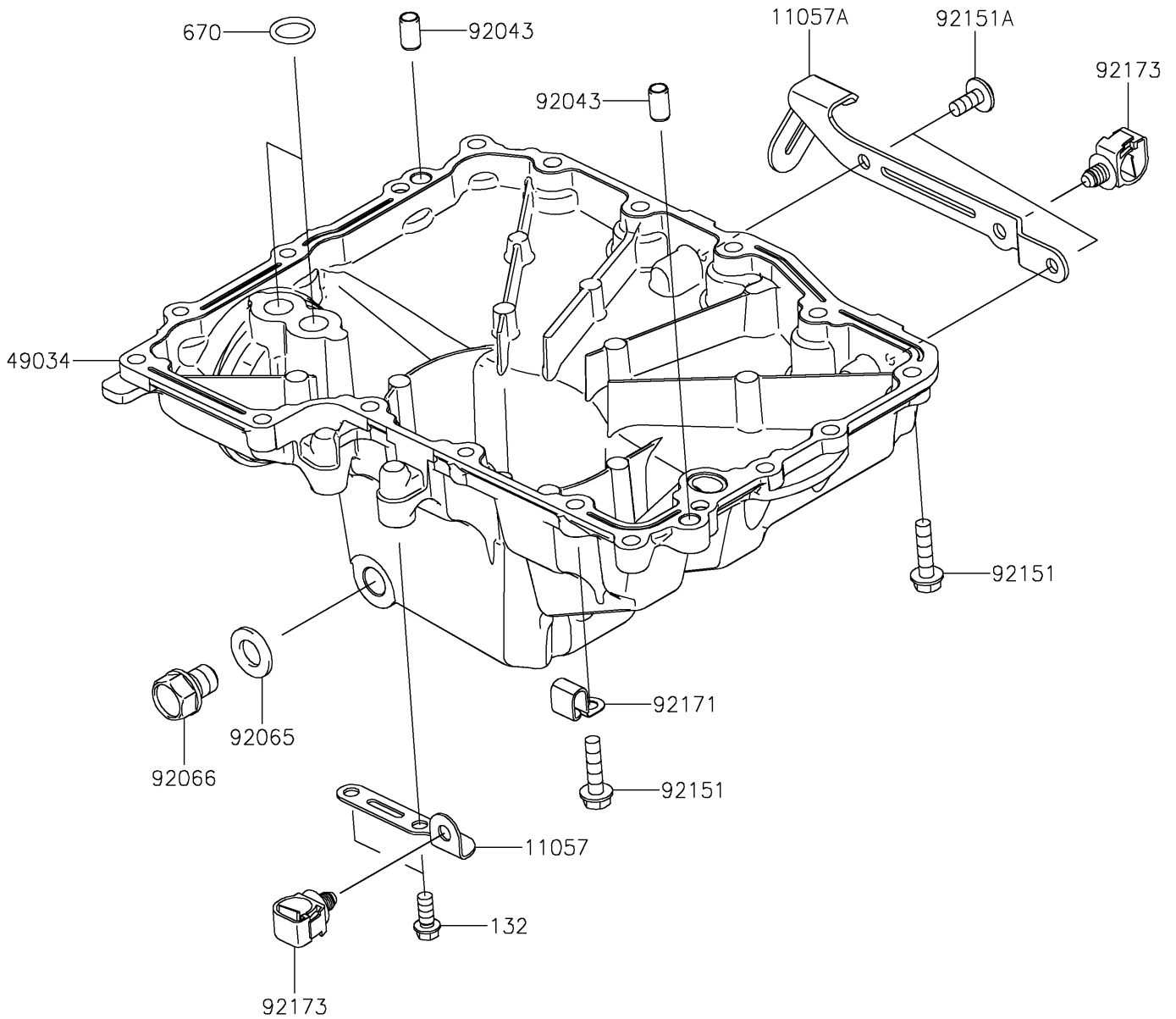

## 2020 Z900RS ABS PARTS LIST

### Oil Pan

ITEM NAME	PART NUMBER	QUANTITY
BRACKET (Ref # 11057)	11057-1316	1
BRACKET,OXYGEN SENSOR (Ref # 11057A)	11057-1595	1
PAN-OIL (Ref # 49034)	49034-0578	1
PIN,6.2X8X14 (Ref # 92043)	92043-1263	2
GASKET,12X22X2 (Ref # 92065)	92065-097	1
PLUG,12X15 (Ref # 92066)	92066-0079	1
BOLT,FLANGED,6X25 (Ref # 92151)	92151-1225	18
BOLT,SOCKET,6X14 (Ref # 92151A)	92151-1654	2
CLAMP (Ref # 92171)	92171-0534	1
CLAMP,12MM DIA. (Ref # 92173)	92173-0736	2
BOLT-FLANGED-SMALL,6X14 (Ref # 132)	132BC0614	2
O RING,14MM (Ref # 670)	670D2014	2