

2021 Ninja® ZX™ -6R PARTS DIAGRAM

Front Fender(s)

F2171

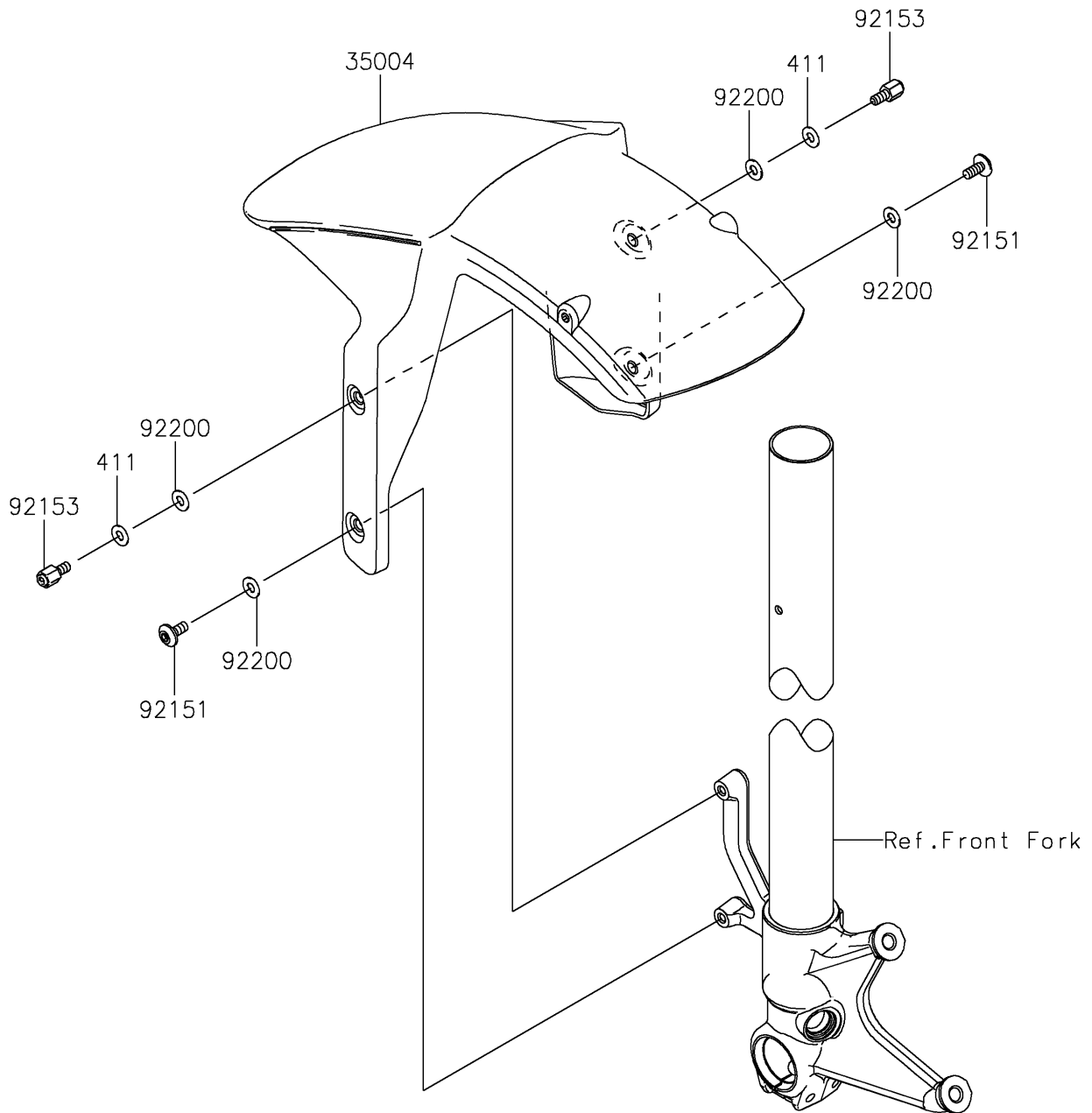

2021 Ninja® ZX™ -6R PARTS LIST

Front Fender(s)

ITEM NAME	PART NUMBER	QUANTITY
FENDER-FRONT,L.GREEN (Ref # 35004)	35004-0118-777	1
WASHER-PLAIN,6MM (Ref # 411)	411AB0600	2
BOLT,SOCKET,6X14 (Ref # 92151)	92151-1654	2
BOLT,6MM (Ref # 92153)	92153-0335	2
WASHER,6.5X14X1 (Ref # 92200)	92200-1388	4