

2021 KLX®300SM PARTS DIAGRAM

Clutch

E1350

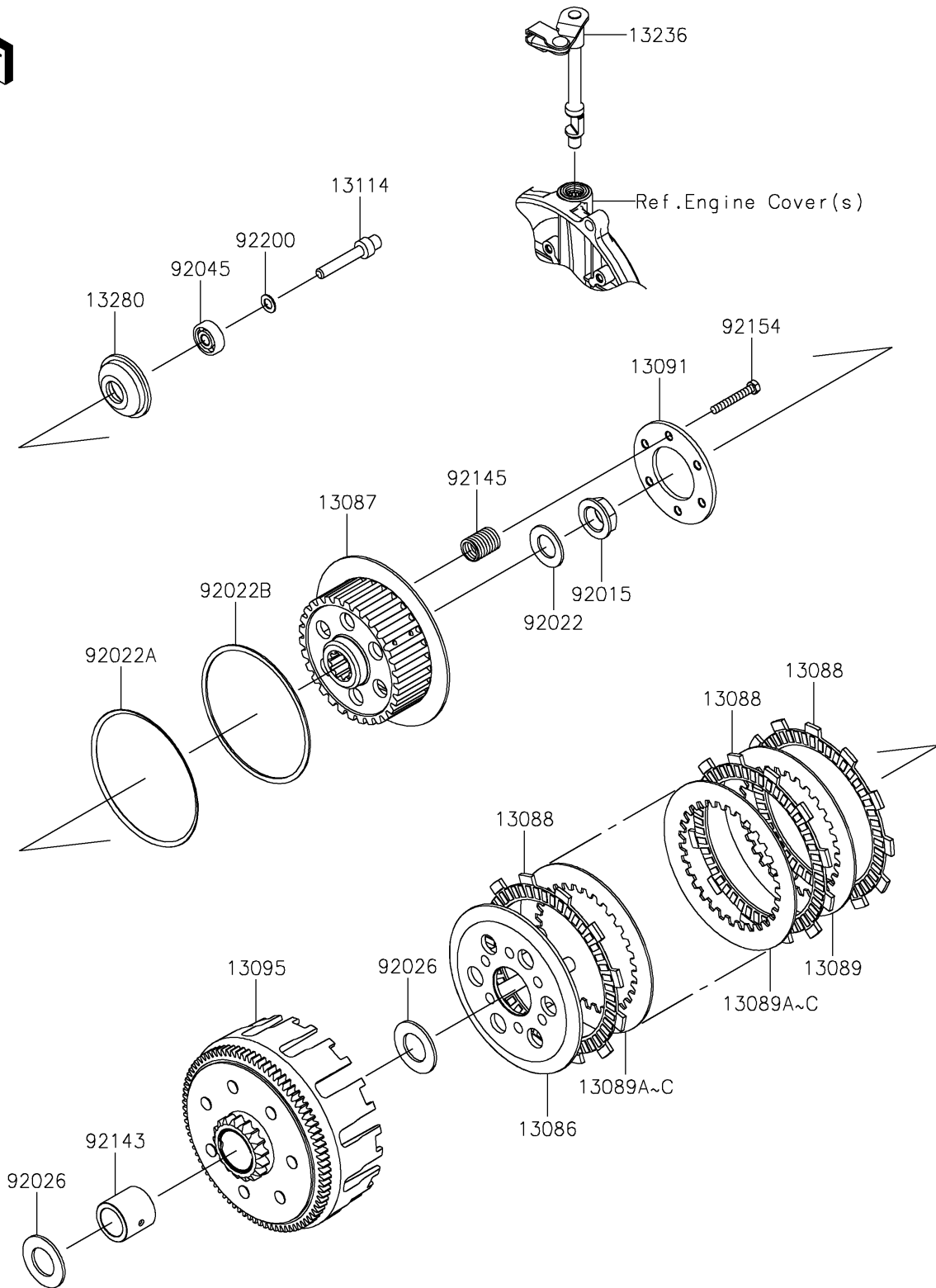

2021 KLX®300SM PARTS LIST

Clutch

ITEM NAME	PART NUMBER	QUANTITY
WHEEL-CLUTCH (Ref # 13086)	13086-0004	1
HUB-CLUTCH (Ref # 13087)	13087-0045	1
PLATE-FRICTION (Ref # 13088)	13088-0042	7
PLATE-CLUTCH (Ref # 13089)	13089-1085	1
PLATE-CLUTCH,T=1.6 (Ref # 13089A)	13089-1094	5
PLATE-CLUTCH,T=2.0 (Ref # 13089B)	13089-1116	AR
PLATE-CLUTCH,T=1.2 (Ref # 13089C)	13089-1117	AR
HOLDER,CLUTCH SPRING (Ref # 13091)	13091-1683	1
HOUSING-COMP-CLUTCH (Ref # 13095)	13095-0576	1
PUSHER-CLUTCH (Ref # 13114)	13114-1068	1
LEVER-COMP (Ref # 13236)	13236-0158	1
HOLDER,CLUTCH PUSHER (Ref # 13280)	13280-0812	1
NUT,16MM (Ref # 92015)	92015-1581	1
WASHER,16.3X29X1.75 (Ref # 92022)	92022-1356	1
WASHER,JUDDER SPRING (Ref # 92022A)	92022-1974	1
WASHER,JUDDER SPRING SEAT (Ref # 92022B)	92022-1993	1
SPACER,20.3X36.6X2 (Ref # 92026)	92026-0725	2
BEARING-BALL,627 (Ref # 92045)	92045-1236	1
COLLAR (Ref # 92143)	92143-1959	1
SPRING (Ref # 92145)	92145-0637	6
BOLT,UPSET,5X35 (Ref # 92154)	92154-0065	6
WASHER,7X12.5X0.8 (Ref # 92200)	92200-0909	1