

1990 KX500 PARTS DIAGRAM

Kickstarter Mechanism

E1340

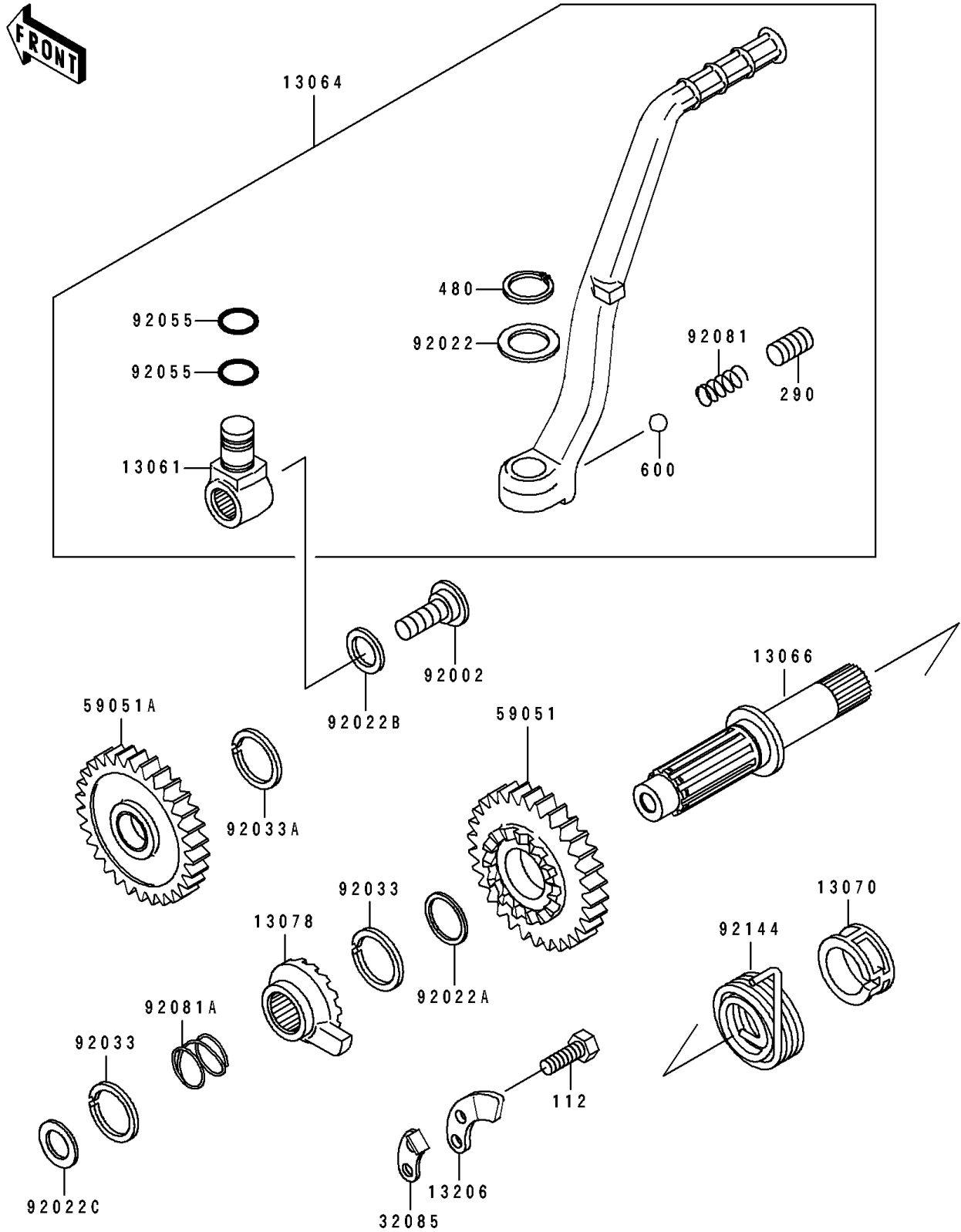

1990 KX500 PARTS LIST

Kickstarter Mechanism

ITEM NAME	PART NUMBER	QUANTITY
BOSS,KICK PEDAL (Ref # 13061)	13061-1253	1
LEVER-ASSY-KICK,PEDAL (Ref # 13064)	13064-1134	1
SHAFT-KICK (Ref # 13066)	13066-1056	1
GUIDE,KICK SPRING (Ref # 13070)	13070-011	1
RATCHET (Ref # 13078)	13078-007	1
GUIDE-KICK (Ref # 13206)	13206-1003	1
STOPPER,KICKSTARTER (Ref # 32085)	13072-014	1
GEAR-SPUR,KICKSTARTER,26T (Ref # 59051)	59051-1149	1
GEAR-SPUR,IDLE,26T (Ref # 59051A)	59051-1150	1
BOLT,DISC PLATE,8X20 (Ref # 92002)	92002-1736	1
WASHER,16.3X24X1 (Ref # 92022)	92022-1205	1
WASHER,25.3X30X0.5 (Ref # 92022A)	92022-159	1
WASHER (Ref # 92022B)	92022-1944	1
WASHER,20.5X25.5X0.5 (Ref # 92022C)	92022-252	1
RING-SNAP,24MM (Ref # 92033)	92033-026	2
RING-SNAP,18MM (Ref # 92033A)	92033-029	1
RING-O,10X1.5 (Ref # 92055)	92055-061	2
SPRING,KICK PEDAL (Ref # 92081)	92081-020	1
SPRING (Ref # 92081A)	92081-097	1
SPRING,KICKSTARTER (Ref # 92144)	92144-1115	1
BOLT-UPSET (Ref # 112)	112G0618	2
SCREW-SET-SOCKET (Ref # 290)	290P0812	1
CIRCLIP-TYPE-C,15MM (Ref # 480)	480J1500	1
BALL-STEEL,1/4" (Ref # 600)	600A0800	1